



CUSHMAN™

OWNER'S GUIDE
HAULER Pro X

653036 – A

ISSUED AUGUST 2016

 **WARNING**

Read and comply with all of the instructions and safety precautions in this manual and on all product labels.

Failure to follow the safety precautions could result in serious injury or death.

 **WARNING**

CALIFORNIA Proposition 65

Motor vehicles may contain fuels, oils and fluids, battery posts, terminals, and related accessories which contain lead and lead compounds and other chemicals identified by the State of California to potentially cause cancer, birth defects, and other reproductive harm. These chemicals are found in vehicles, vehicle parts and accessories, both new and replacements. During maintenance, these vehicles generate used oil, waste fluids, grease, fumes, and particulates, all identified by the State of California to potentially cause cancer and birth defects or other reproductive harm.

Posted in accordance with Proposition 65 and California Health and Safety Code Section 25249.5, et seq.

 **WARNING**

Never modify the vehicle in any way that will alter the weight distribution of the vehicle, decrease its stability or increase the speed beyond the factory specifications. Such modifications can cause serious personal injury or death. The manufacturer, **TEXTRON SPECIALIZED VEHICLES (TSV Augusta)**, prohibits and disclaims responsibility for any such modifications or any other alteration which would adversely affect the safety of the vehicle.

OWNER'S GUIDE

72V ELECTRIC

HAULER Pro X

Starting MODEL YEAR 2017

CONTACT INFORMATION

Textron Specialized Vehicles, Inc.

1451 Marvin Griffin Road.

Augusta, Georgia, USA 30906-3852

North America:

Technical Assistance & Warranty PHONE: 1-800-774-3946, FAX: 1-800-448-8124

Service Parts PHONE: 1-800-438-3946, FAX: 1-800-752-6175

International PHONE: 001-706-798-4311, FAX: 001-706-771-4609

cushmancomm@textron.com

WELCOME

Thank you for purchasing this vehicle. Before driving your new vehicle, read this owner's manual to familiarize yourself with safe driving practices, operation, features and controls.

This manual contains instructions for minor maintenance only. Information about major repairs can be found in the repair manual. Your dealer has thorough knowledge of your vehicle and wants your total satisfaction with your purchase. We recommend you return to your dealership for all of your service needs during, and after the warranty period.

Repair or replacement parts can be purchased from your dealer or through the manufacturer's parts and accessories department.

These are original instructions as defined by 2006/42/EC.

Textron Specialized Vehicles, Inc. maintains the right to change the design of the vehicle without responsibility to make the changes on units purchased before changes were made. The information in this manual can change without notice.

All information in this owner's manual is based on the latest product information at the time of publication. Due to constant improvements in the design and quality of production components, some discrepancies may be found between your vehicle and the information presented in this publication. The content in this publication is intended for reference use only. The manufacturer is not liable for omissions or inaccuracies. Any reprinting or reuse of the content in this publication, whether whole or in part, is expressly prohibited.

Printed in USA

INTRODUCTION

MANUFACTURER’S INTENDED USE7
 WARRANTY AND REGISTRATION7
 BATTERY PROLONGED STORAGE7
 BATTERY DISPOSAL7
 VEHICLE IDENTIFICATION NUMBERS8
 REPAIR AND PARTS MANUALS8

SAFETY

SAFETY LABELS9
 Operation (P/N 651654)9
 Operation (P/N 608529) (If equipped with card holder)10
 Bed Latch Warning CE (P/N 74099G01)10
 Load Bed (P/N 74821G01)10
 Load Bed (P/N 35980G02)11
 Rear-Facing Seat / Load Deck Warning (P/N 651665)11
 Pinch Warning (P/N 651671)11
 Run/Tow Switch Operation (P/N 653470) (For cars equipped with IntelliBrake™)11
 Run/Tow Switch Operation (P/N 633950)12
 MAXIMUM CARGO LOAD / MAXIMUM WEIGHT CAPACITY12
 TIRE PRESSURE12
 OPERATOR SAFETY12
 Unauthorized Operation13
 Operating without Instruction13
 Alcohol or Drugs13
 Passenger13
 Before Operating14
 Load Operation14
 Driving in Reverse14
 Driving a Damaged Vehicle14
 Driving at Maximum Speeds14
 Driving on Pavement14
 Driving on Public Roads14
 Turning14
 Driving Uphill14
 Driving Downhill14
 Stalling on a Hill15
 Tires15
 Slippery Terrain15
 BATTERY CHARGING15
 VEHICLE LIFTING15
 VEHICLE MODIFICATION15
 MAINTENANCE SAFETY15

FEATURES AND CONTROLS

KEY SWITCH17
 HEADLIGHT SWITCH17
 ELECTRIC BED LIFT SWITCH (IF EQUIPPED)17

TABLE OF CONTENTS

STATE OF CHARGE METER	17
HORN	17
CUP HOLDER	17
12V OUTLET (IF EQUIPPED)	17
USB PORT (IF EQUIPPED)	17
HOUR METER (IF EQUIPPED)	18
STEERING WHEEL	18
TURN SIGNAL (IF EQUIPPED)	18
BRAKE PEDALS	18
Brake Pedal	18
Parking Brake Pedal	18
ACCELERATOR PEDAL	19
DIRECTION SELECTOR	19
SEAT BOTTOM	19
GLOVE BOX / STORAGE COMPARTMENTS	19
TRUCK BED	19
Manual Bed Release Lever	19
Electric Lift	19
Flip Seat/Load Deck (If Equipped)	19
CANOPY TOP AND WINDSHIELD	20

OPERATION

SAFETY	23
BEFORE INITIAL USE	23
PRE-RIDE INSPECTION	23
ENVIRONMENTAL AWARENESS	24
CHARGER	24
On Board Charger	24
PERFORMANCE FEATURES	25
Speed Control	25
Pedal-Up Braking	25
Walk-Away Feature	25
Anti-Roll Back Feature	25
Anti-Stall Feature	25
High Pedal Disable Feature	26
Diagnostic Mode Feature	26
STARTING AND STOPPING THE VEHICLE	26
Starting on a Hill	26
ACCELERATING	26
BRAKING	27
Coasting	27
DRIVING PROCEDURE	27
Coasting	27
DRIVING WITH A PASSENGER	27
SLIPPERY SURFACES	28
DRIVING UPHILL	28
TRAVERSING HILLSIDES	28
DRIVING DOWNHILL	28

STALLING ON A HILL	29
DRIVING IN REVERSE	29
PARKING THE VEHICLE	29
HAULING CARGO	30
Maximum Cargo Load / Maximum Weight Capacity	30
Flip Seat/ Load Deck Operation (If Equipped)	31
TRUCK BED OPERATION	32
Load Bed (P/N 74821G01)	32
DUMPING THE TRUCK BED	32
TOWING	33
WINCH	
WINCH SAFETY	35
WINCH OPERATION	36
WINCH CABLE CARE	37
SHOCK LOADING	38
WINCH MAINTENANCE SAFETY	38
MAINTENANCE	
MAINTENANCE SAFETY	39
SCHEDULED MAINTENANCE	39
Severe Use Conditions	40
SCHEDULED MAINTENANCE CHART	40
RECOMMENDED LUBRICANTS AND FLUIDS	41
REPLACEMENT OF MAINTENANCE ITEMS	41
LIFTING THE VEHICLE	42
Lifting Front	42
Lifting Rear	42
Lowering Vehicle	42
VEHICLE CLEANING AND CARE	43
Washing the Vehicle	43
Polishing the Vehicle	43
TIRES	43
Tire Pressure	44
Tire Repair	44
Tire Replacement	44
WHEELS	44
Wheel Removal	44
Wheel Installation	45
LIGHTS	45
Halogen Headlight Bulb Replacement	45
LED Headlight Assembly Replacement	45
Taillight	45
FUSE REPLACEMENT	46
CONTROLLER SYSTEM TEST	46
REAR AXLE	46
Checking the Lubricant Level	46
LUBRICATION	46
BRAKES	47

TABLE OF CONTENTS

Periodic Brake Test	47
BATTERY	47
BATTERY DISPOSAL	48
BATTERY CLEANING	48
BATTERY CHARGING AND MAINTENANCE	49
At Each Charging Cycle	49
Monthly	49
Electrolyte Level and Water	49
BATTERY REPLACEMENT	50
BATTERY STORAGE	51
BATTERY CHARGING	52
AC Voltage	52
BATTERY FAULT DIAGNOSIS	52
Using A Hydrometer	54
TRANSPORTING THE VEHICLE	55
Towing the Vehicle	55
Hauling the Vehicle	55
 SPECIFICATIONS	
HAULER PRO-X - VEHICLE SPECIFICATIONS	55

INTRODUCTION

The following symbols appear throughout this manual and on vehicle labels. Your safety is involved when these symbols are used. Become familiar with their meanings before reading the manual.



DANGER indicates a hazardous situation that, if not avoided, will result in death or serious injury.



WARNING indicates a hazardous situation, if not avoided, could result in death or serious injury.



CAUTION indicates a hazardous situation that, if not avoided, could result in minor or moderate injury.



The **PROHIBITION SAFETY SIGN** indicates an action **NOT** to take in order to avoid hazard.



The **MANDATORY ACTION SIGN** indicates an action that **NEEDS** to be taken to avoid a hazard.



WARNING Failure to comply with the warnings in this manual can result in severe injury or death.



WARNING Read this entire manual carefully before operating this vehicle. Do not attempt to operate this vehicle until you have thorough knowledge of the controls and features.



WARNING Regular inspections and maintenance, along with good operating techniques, will help ensure your safe enjoyment of the capabilities and reliability of this vehicle.

This vehicle was designed and manufactured in the United States of America (USA). The standards and specifications in the following information originate in the USA unless otherwise indicated.

When servicing motors, all adjustments and replacement components must be per original vehicle specifications to maintain the USA Federal and State emission certification applicable at the time of manufacture.

MANUFACTURER'S INTENDED USE

This vehicle is designed and manufactured for off road use only. Use on public streets, roads or highways is illegal in most areas and increases the risk of an accident involving other vehicles and people. This vehicle does not meet FMVSS (Federal Motor Vehicle Safety Standards) for public street, road or highway use.

Check all laws and regulations before choosing an area to operate your vehicle.

WARRANTY AND REGISTRATION

Use Original Equipment Manufacturer (OEM) approved parts to keep the warranty effective.

Tampering with or adjusting the governor to allow the vehicle to operate above factory specifications will void the vehicle warranty.

All information, including coverage, limitations, exclusions and how to obtain warranty service is included in the literature package with the purchase of the vehicle. It can also be obtained from your TSVdealer.

A registration card is included in the literature package with the purchase of the vehicle. The vehicle can also be registered online at www.cushman.com.

BATTERY PROLONGED STORAGE

Batteries discharge over time. The rate of discharge changes according to the ambient temperature, the age and condition of the batteries.

Completely charged batteries will not freeze in winter temperatures unless the temperature is less than -75°F (-60°C).

BATTERY DISPOSAL

Lead-acid batteries are recyclable. Return discarded batteries to distributor, manufacturer or lead smelter for recycling. For neutralized spills, put residue in acid-resistant containers with absorbent material such as sand. Dispose in accordance with local, state and federal regulations for acid and lead compounds. Contact local or state environmental authorized people for the disposal information.

INTRODUCTION

VEHICLE IDENTIFICATION NUMBERS

PART A

[]	
MODEL []	
DATE CODE []	
SERIAL No. []	
Bar Code []	GVW Lb / kg Lb / kg W Batt Nom Power Hp / kw

PART B

Rated Capacity W/Operator lb/kg	/	System voltage	V
Lb/kg W/O Batt	/	Max Draw bar lb/kg	/
Max Batt lb/kg	/		
[]			

SERIAL No. []

Bar Code []

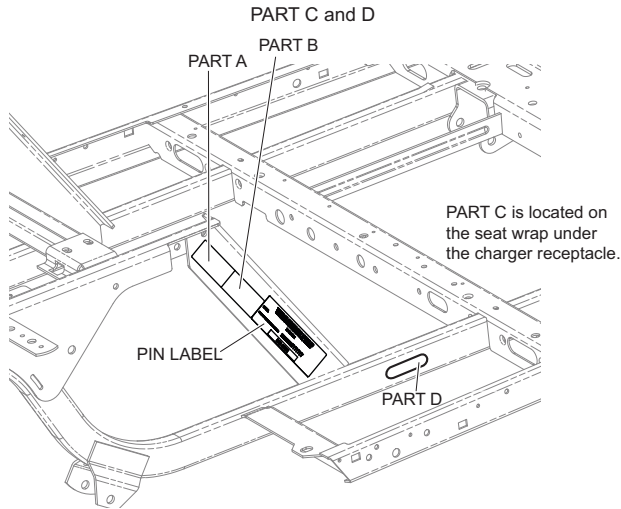

Record the vehicle identification numbers in the spaces provided below. These identification numbers is required when ordering parts from TSV.

Vehicle Model Number: _____

Frame PIN: _____

REPAIR AND PARTS MANUALS

The following manuals can be purchased through a TSV dealer:

- repair manual
- parts manual

SAFETY

For questions about your vehicle or the material in this manual, see the contact information on page 1 or the back of this publication.

Certain replacement parts can be used independently and/or in combination with other accessories to modify a TSV (Augusta) manufactured vehicle to permit the vehicle to operate at or in excess of 20 mph. When a TSV-manufactured vehicle is modified in any way by the Distributor, Dealer or customer to operate at or in excess of 20 mph on public streets or roads. UNDER FEDERAL LAW the modified product will be a Low Speed Vehicle (LSV) subject to the strictures and requirements of Federal Motor Vehicle Safety Standard 571.500. In these instances, pursuant to Federal law the Distributor or Dealer MUST equip the product with headlights, rear lights, turn signals, seat belts, top, horn and all other modifications for LSV's mandated in FMVSS 571.500, and affix a Vehicle Identification Number to the product in accordance with the requirements of FMVSS 571.565. Pursuant to FMVSS 571.500, and in accordance with the State laws applicable in the places of sale and use of the product, the Distributor, Dealer or customer modifying the vehicle also will be the Final Vehicle Manufacturer for the LSV, and required to title or register the vehicle as mandated by State law.

Information on FMVSS 571.500 is found at Title 49 of the Code of Federal Regulations, section 571.500. For information online, go to www.ecfr.gov.

TSV will NOT approve Distributor, Dealer or customer changes that change a TSV product into a Low Speed Vehicle (LSV).

This vehicle meets the current applicable standard for safety and performance requirements.

SAFETY LABELS

Safety and warning labels are on the vehicle for your protection. Read and comply with the instructions on the labels carefully. If any label shown in this manual is different from the label on your vehicle, always follow the instructions on the vehicle label.

If a label comes off or becomes illegible, contact your TSV dealer for a replacement. The part number is provided in this manual, printed on the label, or can be obtained from your dealer.

Operation (P/N 651654)

Located on the steering wheel.

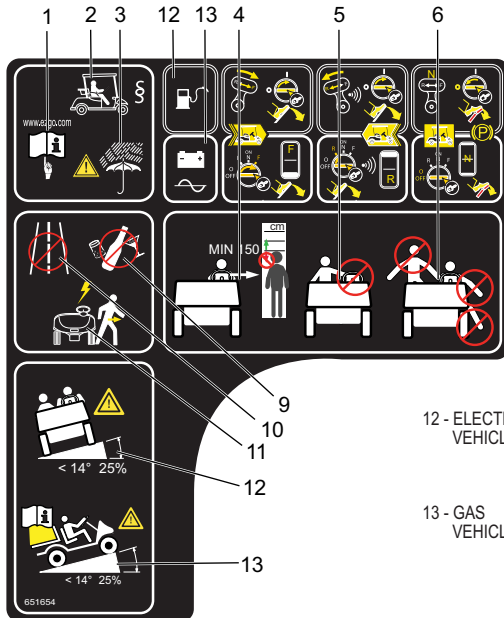

- 1 - READ THE MANUAL
 - 2 - DRIVE IN ACCORDANCE WITH LOCAL LAWS AND REGULATIONS
 - 3 - USE CAUTION IN BAD WEATHER
 - 4 - MINIMUM HEIGHT REQUIRED TO DRIVE
 - 5 - NO OPERATION FROM PASSENGER SEAT
 - 6 - NO STANDING AND KEEP ENTIRE BODY INSIDE VEHICLE
 - 7 - REFER TO OWNER'S MANUAL FOR CARGO INFORMATION
 - 8 - MAXIMUM CROSS RAMP OR HILL
 - 9 - NO OPERATION IF USING DRUGS OR ALCOHOL
 - 10 - NO OPERATION ON PUBLIC ROADS
 - 11 - EXIT VEHICLE WHEN LIGHTNING IS IN AREA
- | | |
|--|--|
| <p>12 - ELECTRIC VEHICLE</p> <p>FORWARD OPERATION
- KEY IN F
- PRESS ACCELERATOR GRADUALLY</p> <p>REVERSE OPERATION
- KEY IN R
- PRESS ACCELERATOR GRADUALLY</p> <p>PARK VEHICLE
- TURN KEY TO OFF</p> | <p>13 - GAS VEHICLE</p> <p>FORWARD OPERATION
- TURN KEY TO ON
- PUT DIRECTION SELECTOR TO F
- PRESS ACCELERATOR GRADUALLY</p> <p>REVERSE OPERATION
- TURN KEY TO ON
- PUT DIRECTION SELECTOR IN R
- PRESS ACCELERATOR GRADUALLY</p> <p>PARK VEHICLE
- PUT DIRECTION SELECTOR IN F
- TURN KEY TO OFF
- ENGAGE PARKING BRAKE</p> |
|--|--|

SAFETY

Operation (P/N 608529) (If equipped with card holder)

Located on the steering wheel.

⚠ WARNING

OPERATING INSTRUCTIONS

BEFORE OPERATING

- READ all warning labels and the owner's manual. Contact an authorized dealer or go to the manufacturer's website for a replacement manual.
- This vehicle is equipped for personal use in most communities. However, state law or local rules may require additional equipment in your community.

SAFE OPERATION

- Turn key to **ON** - select "forward" or "reverse" - release the parking brake (gas vehicle only) - then slowly press the accelerator pedal.
- Always bring the vehicle to a complete stop **BEFORE** shifting the direction selector.
- Operate from the driver's seat **ONLY**.

PARKING

- **ALWAYS** fully engage the parking brake and remove the key **BEFORE** leaving the vehicle. In an electric vehicle, set the direction selector to "neutral"; in a gas vehicle, set the direction selector to "forward".

MAINTENANCE

This vehicle requires regularly scheduled maintenance (see the periodic service schedule in your owner's manual). **ONLY** qualified personnel should service this vehicle.

608529

Negative Ground Label (P/N 28203G01) (For CE vehicles)

Located on the seat frame.





NEGATIVE GROUND
BATTERY



SHORTING BATTERY TERMINALS CAN
CAUSE EXPLOSION

28203-G01

Bed Latch Warning CE (P/N 74099G01)

Located on the side panel near rear fender.

KEEP HANDS AND
FINGERS AWAY FROM
DUMP BED.

74099-G01

DO NOT STAND
BEHIND DUMP
BED.

Load Bed (P/N 74821G01)

Located on the truck bed.

WARNING
READ THE MANUAL

SECURE LOAD
MAX BED WEIGHT

NO PASSENGERS
IN LOAD BED

HIGH CENTER OF GRAVITY
MAY CAUSE TIP OVER





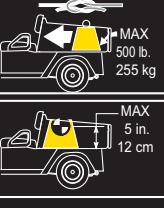

MAX
500 lb.
255 kg

MAX
5 in.
12 cm



MAX
100 lb.
45 kg

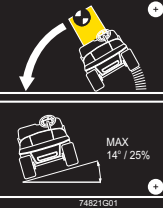

MAX
14° / 25%

74821G01

DO NOT FILL GAS
CAN IN LOAD BED

MAX CENTER OF
GRAVITY HEIGHT
ABOVE FLOOR

MAX TAILGATE
LOAD

MAX SIDE
SLOPE 14°

Load Bed (P/N 35980G02)

WARNING READ THE MANUAL	SECURE LOAD MAX BED WEIGHT	HIGH CENTER OF GRAVITY MAY CAUSE TIP OVER	NO PASSENGERS IN LOAD BED
	DO NOT FILL GAS CAN IN LOAD BED	MAX CENTER OF GRAVITY HEIGHT ABOVE FLOOR	MAX SIDE SLOPE 14°

Rear-Facing Seat / Load Deck Warning (P/N 651665)

If your vehicle has a rear flip-up seat, this label will be located on the rear-facing seat handle.

NO CHILDREN	TWO PASSENGER MAX ON REAR-FACING SEAT	KEEP ARMS AND LEGS INSIDE OF VEHICLE	DO NOT STAND IN FRONT OR BEHIND	REAR-FACING SEAT/DECK INSTRUCTIONS
REMAIN SEATED WITH FEET ON FLOOR AND HOLD ONTO HAND RAILS				NEVER EXIT A MOVING VEHICLE
LOAD WITH HIGH CENTER OF GRAVITY COULD CAUSE TIP OVER	LOAD CENTER OF GRAVITY MAX LOAD HEIGHT	SECURE LOAD AS FAR FORWARD AS POSSIBLE MAX CARGO WEIGHT	DO NOT ALLOW PASSENGERS TO RIDE IN LOAD BED	

Pinch Warning (P/N 651671)

Located on rear facing seat frame for the vehicles with rear facing seat.

		PINCH WARNING KEEP HANDS AND FINGERS AWAY
--	--	---

Run/Tow Switch Operation (P/N 653470) (For cars equipped with IntelliBrake™)

Located on the run/tow switch.

SAFETY

Run/Tow Switch Operation (P/N 633950)

Located on the run/tow switch.

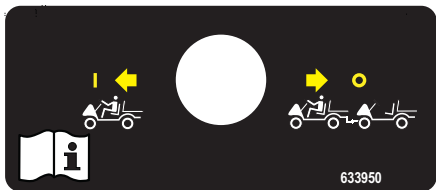

MAXIMUM CARGO LOAD / MAXIMUM WEIGHT CAPACITY

WARNING

Exceeding the weight capacities can cause loss of vehicle control and possible injury or death.

Maximum Cargo Load Capacity	500 lbs. (255 kg)
Maximum Vehicle Weight Capacity	900 lbs. (408 kg)
Maximum Load Deck Capacity (If equipped with rear facing seat)	250 lbs. (110 kg)

- Do not exceed the maximum cargo load capacity.
- Do not exceed the maximum vehicle weight capacity (includes weight of operator, passenger, cargo and accessories).

TIRE PRESSURE

WARNING

Improper tire pressure or uneven tire pressure can cause loss of vehicle control and possible injury or death.

Maintaining correct tire inflation pressure is essential for safe vehicle operation. You can vary the inflation pressure, within the recommended range to suit the condition of the terrain.

TIRE PRESSURE RANGE	TERRAIN CONDITIONS	RECOMMENDATION
18 - 22 psi (124 - 152 kPa)	hard surfaces or pavement	Inflate to higher pressure within the range; never exceed maximum pressure indicated.
	soft terrain or turf	Inflate to lower pressure within the range to reduce potential damage to the terrain or turf.

OPERATOR SAFETY

Safe and responsible use of this vehicle is necessary to prevent dangerous conditions for the operator, passengers and other people in the area of operation. This section of the manual provides information on the safe operation of the vehicle. Make sure you read, understand and comply with all of this information to decrease the risk of personal injury or death.

WARNING

Serious injury or death can occur if you do not follow the instructions and procedures shown in this owner's manual.

- Read this entire manual and all product labels carefully. Follow the safety information and operating procedures described.
- Operate your vehicle responsibly to prevent dangerous conditions for the operator, passengers and other people in the area of operation
- Operate your vehicle responsibly and keep the vehicle in safe condition of operation.
- A damaged vehicle, or a vehicle that is not functioning properly is dangerous and must not be operated until repairs are made.
- Do not carry a passenger until you have a minimum of two hours driving experience on this vehicle.
- Keep feet, legs, hands and arms inside the vehicle at all times.
- The driver must keep both hands on the steering wheel and both feet on the floor or a pedal.

- Inspect the vehicle before each use to make sure it is in safe operating condition. Perform the pre-ride inspection described in this manual. See page 23.
- Always have the vehicle checked by an authorized dealer if it is involved in an accident.
- Always put the direction selector in forward (F) and engage the parking brake before you exit the vehicle.
- Remove the ignition key when the vehicle is not in use to prevent accidental starting, unauthorized use by someone below the age of 16, or someone without a driver's license and proper training.
- Drive the vehicle at appropriate speeds for the terrain and conditions. Be aware of environmental conditions that change the terrain and your ability to control the vehicle.
- Do not drive on excessively steep hills. Evaluate the terrain before descending a hill. Drive slowly and deliberately. Use the brake to limit speed and maintain control. Sudden braking or turning can cause loss of vehicle control. Drive straight down the hill; do not drive across the hill.
- Operate only in approved areas. Follow all applicable safety rules for the area.
- Avoid driving on terrain that is too rough for your vehicle's capabilities and your driving skills.
- Before you drive in the reverse direction, make sure the area behind the vehicle is clear. Accelerate slowly and avoid making sharp turns.
- Make sure the direction selector is in the correct position before you press the accelerator pedal.
- Decrease speed before and during turns.
- Decrease speed when driving on wet or slippery surfaces.
- Bring the vehicle to a complete stop before you move the direction selector.
- Do not exceed the cargo or vehicle weight capacities. Do not exceed the occupant capacity. See *SPECIFICATIONS* on page 53 for the vehicle load and seat capacity.
- If there is a risk of lightning, leave the vehicle and look for a safe location to wait until the lightning has stopped.

Additional information about safety is included throughout this manual or can be obtained from your local TSV dealer.



WARNING Failure to operate this vehicle as instructed can cause collision, loss of control or rollover resulting in severe injury or death. Follow all safety warnings in this section of the owner's manual. See the **OPERATION** section of the owner's manual for operating procedures and additional safety information.

Unauthorized Operation



This vehicle is for adult use only. Any person below the age of 16 is not permitted to operate the vehicle.

Any person who does not have a valid driver's license is not permitted to operate the vehicle.

Any person who is below the height of 59 in. (150 cm) is not permitted to operate the vehicle.

Leaving the keys in the ignition allows unauthorized operation of the vehicle by someone under 16 years of age, an unlicensed driver or someone who does not meet the height requirement. Always remove the ignition key when the vehicle is not in operation.

Operating without Instruction



Operation of this vehicle without proper instruction increases the risk of an accident. The operator must understand how to operate the vehicle correctly in different situations and on different types of terrain.

All operators must read, understand and comply with the owner's manual and all warning and instruction labels before operating the vehicle.

Alcohol or Drugs



Operation of the vehicle during or after consuming alcohol or drugs can adversely affect operator judgment, reaction time, balance and perception.

Never drink alcohol or use drugs or medications before or during operation of the vehicle.

Passenger

All passengers must be at least 59 in. (150 cm) tall. Passengers must be able to sit with their back against the seat, and both feet on the floor.

For additional safety and operational information, see *Driving with a Passenger* on page 27.

SAFETY

Before Operating

Perform the *PRE-RIDE INSPECTION* on page 23 before each use to make sure the vehicle is in safe operating condition. Failure to inspect and confirm that the vehicle is safe to operate increases the risk of an accident.

Follow all inspection and maintenance procedures and schedules described in this owner's manual. See *SCHEDULED MAINTENANCE* on page 39.

Load Operation

The weight of cargo and occupants affects vehicle operation. Carefully calculate how the vehicle is loaded and how to safely operate it. Follow the instructions in this manual for loading guidelines and tire pressure.

Do not exceed weight capacities specified for your vehicle. Capacities are listed in *Maximum Cargo Load / Maximum Weight Capacity* on page 12 of this manual, and also on the label affixed to the truck bed. As passenger weight increases, cargo weight needs to be adjusted to ensure the maximum vehicle weight capacity is not exceeded.

Tire pressure must be adjusted to accommodate the load being carried. See *Tire Pressure* on page 12 for pressure specifications.

Verify tire pressure, and drive slowly and carefully to maintain control of the vehicle if driving under any of the following conditions:

- passenger and/or cargo exceeds half the maximum weight capacity
- driving over obstacles
- towing
- climbing a hill

Driving in Reverse

Make sure the area behind the vehicle is clear before operating in reverse. After making sure it is clear and safe to operate in reverse, accelerate slowly. Avoid making sharp turns in reverse. Refer to *Driving in Reverse* on page 29 for operational information.

Driving a Damaged Vehicle

Driving a damaged vehicle is not safe.

If your vehicle has been involved in any type of accident, have it inspected by a qualified service dealer to verify that it is safe for operation.

Driving at Maximum Speeds

Maximum speed operation increases risk of loss of control. Always drive at a speed that is appropriate for the terrain, visibility, operating conditions and your skill and experience level. Use the brake to control speed and maintain control of the vehicle.

Driving on Pavement

Driving the vehicle on paved surfaces can affect handling characteristics and increase tire wear.

If possible, avoid driving on paved surfaces. If unavoidable, drive slowly, travel short distances and avoid sudden turns or stops.

Driving on Public Roads

Driving this vehicle on public streets, roads or highways could result in a collision with another vehicle. Never drive this vehicle on any public street, road or highway, including dirt and gravel roads, unless they are designated for off road use. Most areas prohibit the operation of this vehicle on public streets, roads or highways, and can result in traffic violations and fines.

Turning

Improper or careless turning can cause loss of traction, loss of control, accident or rollover. Do not turn quickly or at sharp angles. Do not turn at high speeds. Practice turning at slow speeds before attempting to turn at faster speeds.

Driving Uphill

Do not climb hills that are too steep for the vehicle or your driving abilities. Loss of vehicle control or rollover can result from climbing hills incorrectly. Refer to *Driving Uphill* on page 28 for operational information.

Driving Downhill

Inspect the terrain before descending a hill. Avoid driving across hills. Use the brake to limit speed and maintain control. Loss of vehicle control or rollover can result from driving downhill incorrectly. Refer to *Driving Downhill* on page 28 for operational information.

Stalling on a Hill

A rollover can result from stalling or rolling backward while climbing a hill. Drive uphill at a constant speed. See procedure on page 29 for maintaining control of your vehicle if it stalls on a hill.

Tires

Operating the vehicle with incorrect tires or with incorrect or uneven tire pressure can cause loss of control or an accident. Always use the size and type tires specified for the vehicle. See *VEHICLE SPECIFICATIONS* on page 53. Always maintain correct tire pressures as specified in *Tire Pressure* on page 12.

Slippery Terrain

Driving on rough, wet or loose terrain increases the risk of loss of traction or control, accident or rollover. Drive slowly and use correct turning procedures when operating on slippery surfaces.

Tires that have lost traction, and then regain traction suddenly, can cause loss of vehicle control or rollover.

Refer to *Slippery Surfaces* on page 28 for operational information.

BATTERY CHARGING

Explosive hydrogen gas is created during the charge cycle of the batteries. Good ventilation is necessary to remove gas from enclosed spaces. The air must change every 12 minutes.

Never charge a vehicle near flammable materials, open flame or sparks. Never charge a vehicle near gas water heaters and furnaces.

VEHICLE LIFTING

The vehicle must be on a firm and level surface for lifting. Remain constantly aware that the vehicle is not stable during the lifting process. Do not get under a vehicle until you verify that it is stable on the jack stands. Never get under a vehicle while it is on a jack only. Put wheel chocks in front and behind the wheels that are not being lifted. Do not allow anyone to remain or get on the vehicle at any time during the lifting process.

Read and comply with all warnings and follow the lifting procedures described on page 42.

VEHICLE MODIFICATION

Do not install any accessory not approved by TSV. Do not modify the vehicle to increase speed or power. Any modifications or installation of accessories not approved by TSV can create a safety hazard and increase the risk of injury.

The warranty will be terminated if the vehicle is modified to increase vehicle speed or power.

The warranty may be terminated if original (or equivalent) replacement parts are not installed on the vehicle.

The addition of some accessories can change the handling characteristics of the vehicle. Use only TSV approved accessories, and familiarize yourself with their function and effect on the vehicle.

MAINTENANCE SAFETY

Routine and scheduled maintenance of this vehicle is necessary to keep your vehicle in safe and reliable condition. This section of the manual provides safety information for performing maintenance on your vehicle. Make sure you read, understand and comply with all of this information to decrease the risk of personal injury or death.

⚠ WARNING Serious injury or death can occur if you do not follow the instructions and procedures shown in this owner's manual.

- Read this entire manual and all product labels carefully. Follow the procedures and comply with the safety information in this manual while performing vehicle service or maintenance.
- Use the tools shown in the tool list and wear the specified safety equipment when performing vehicle service or maintenance.
- Remove all jewelry before you service the vehicle.
- Do not allow loose clothing or hair to contact the moving parts.
- Do not touch hot objects.
- The drive wheels must be lifted and supported on jack stands before you perform any service to the powertrain while the motor is in operation.
- Use wheel chocks and support the vehicle on jack stands. NEVER get under a vehicle that is supported by a jack. Lift the vehicle following instructions. See *LIFTING THE VEHICLE* on page 42.

SAFETY



- When you service the vehicle, always wear eye protection. Be careful when working around batteries, using solvents or compressed air.
- Use insulated tools within the battery area to prevent sparks or battery explosion.
- To prevent the risk of battery explosion, keep all flammable materials, open flames or sparks away from the battery.
- Hydrogen gas is produced as batteries are charged. Charge the battery pack only in well-ventilated areas.
- Maintain constant awareness that some components are heavy, spring loaded, corrosive, explosive, can cause high amperage or get extremely hot. Battery acid and hydrogen gas can cause bodily injury. Keep your hands, face, feet and body away from any area that can expose them to injury if an unexpected situation occurs.
- After you make repairs or do maintenance, test the vehicle in a safe area that is free from vehicle and person traffic.

FEATURES AND CONTROLS

NOTICE: Some accessories continue to operate with the key in the OFF position. Leaving these accessories activated after the vehicle is shut down can cause the battery to discharge.

12V accessories must be connected to the DC to DC converter. Converter is rated for 390 Watt output. Exceeding this power rating may result in unintended accessory operation or failure.

KEY SWITCH

The key switch is a four-position switch.

- OFF; vehicle is disabled.
- REVERSE; activates vehicle electronics and accessory power, and allows driving in reverse direction.
- NEUTRAL; activates vehicle electronics and accessory power.
- FORWARD; activates vehicle electronics and accessory power, and allows driving in forward direction.

HEADLIGHT SWITCH

The headlight switch is a two-position switch.

Two-position:

- upper – on
- lower – off

ELECTRIC BED LIFT SWITCH (If Equipped)

If the vehicle is equipped with an electric bed lift, the switch is last toggle switch on the right on the console.

Press and hold the top of the switch to activate. Press and hold the lower part of the switch to lower the bed back into place.

STATE OF CHARGE METER

The state of charge meter is on the dash panel beside the key switch. It indicates the amount of usable power in the batteries, with F indicating a full charge on the battery pack and E indicating low charge. The yellow light indicates the batteries must be charged immediately.

HORN

The horn switch is the red toggle switch on the console. Press the top of the switch to activate the horn.

CUP HOLDER

The vehicle has a center cup holder that will accommodate two beverage containers. Another cup holder is located to the left of the steering column and will accommodate a larger beverage container.

12V OUTLET (If Equipped)

CAUTION Excessive use of accessories that are connected to the outlet can drain the battery.

A 12V auxiliary outlet is located on the center console.

With the key switch in the ON position, the auxiliary outlet supplies power for any lights and accessories that have a 12V plug.

USB PORT (If Equipped)

A USB port (if equipped) is located on the center console.

With the key switch in the ON position, the USB port supplies power to electronic devices via a USB cable.



FEATURES AND CONTROLS

HOURLY METER (If Equipped)

The hour meter is located under the driver's seat and indicates the vehicle's total hours of operation.

STEERING WHEEL

The steering wheel allows the driver to control the direction of travel.

TURN SIGNAL (If Equipped)

The turn signal switch is located on the steering column and is used to activate the turn signals.



Run/Tow Switch

The Run-Tow/Maintenance/Storage switch is for use when the vehicle has become stalled, inoperative or removed from service. The switch is located under the driver's seat.

BRAKE PEDALS

The brake pedal on vehicles with mechanical brakes is a combination brake and parking brake pedal.

Brake Pedal

The brake pedal is the bottom left pedal on the floorboard. Press the brake pedal to slow the speed or bring the vehicle to a complete stop.

Parking Brake Pedal

The parking brake is the upper pedal. It allows the operator to lock the brake when the vehicle is parked to prevent accidental movement.

To engage the parking brake, press the upper pedal until it locks into place.

Quickly press and release the lower pedal to disengage.

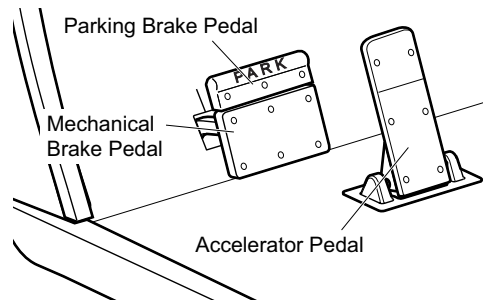

NOTICE: If the key switch is in the ON position and the parking brake is engaged, the brake will release when you press the accelerator pedal and can cause the vehicle to move suddenly. This is a feature to make sure the vehicle is not driven with the parking brake engaged. Pressing the accelerator pedal is not the recommended method to release the parking brake.

ACCELERATOR PEDAL

The accelerator pedal is the right pedal on the floorboard. It activates the engine and controls the acceleration of the vehicle.

Apply slow and steady pressure to the accelerator pedal to increase vehicle speed.

DIRECTION SELECTOR

The direction selector is the key switch. The key switch allows the operator to select F (forward) or R (reverse).

When you leave the vehicle turn the key switch to OFF, set the parking brake and remove the key.

NOTICE: *The parking brake is automatically set on hydraulic brake vehicles with the IntelliBrake™ system.*

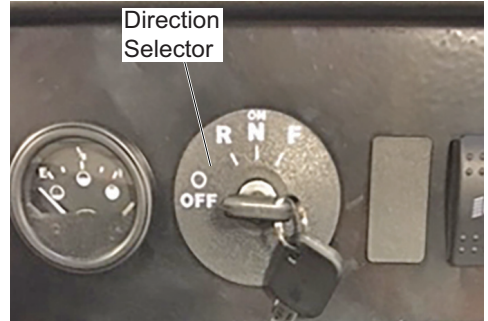

SEAT BOTTOM

The bench seat is designed for two occupants.

Lift up on either hip restraint to pivot the seat bottom forward and access the components underneath. Pivot and lift up on the seat to completely remove it from the vehicle.

GLOVE BOX / STORAGE COMPARTMENTS

The glove box provides storage space for small items. Glove boxes may be equipped with optional shelf and/or glove box door.

TRUCK BED

To prevent injury and property damage, follow all warnings, procedures, and weight capacities described on the label in the truck bed as well as the ones in this owner's manual. See *HAULING CARGO* on page 30 and *DUMPING THE TRUCK BED* on page 32.

The tailgate can be opened for loading and unloading cargo.

Open the tailgate latches and lower the tailgate.

Lift the tailgate and secure the latches to close the tailgate.

Manual Bed Release Lever

The truck bed can be tilted by lifting up the release lever on either side of the vehicle. See *DUMPING THE TRUCK BED* on page 32.

Electric Lift

If the vehicle has an electric lift, the switch is located on the center dash console. Press and hold the top part of the switch to raise the truck bed. Press the bottom part of the switch to lower the truck bed.

See *DUMPING THE TRUCK BED* on page 32.

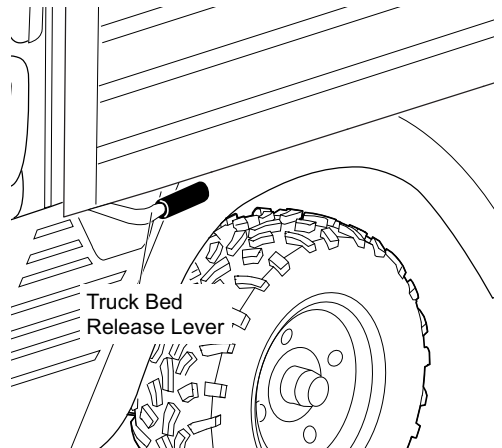

Flip Seat/Load Deck (If Equipped)

Some vehicles are equipped with a feature that functions as a flip seat or a load deck.

When in the upright position, it is a rear seat for two passengers. The seat flips down to form a load deck.

FEATURES AND CONTROLS

⚠ WARNING

Rear passengers must stay in the seat and hold both hip restraints and the rear hand hold when the vehicle is in motion. Always make sure that all passengers are seated and holding on before operating the vehicle.

Do not allow passengers to ride on the load deck. A sudden move or stop can cause severe injury or death to passengers on the load deck.

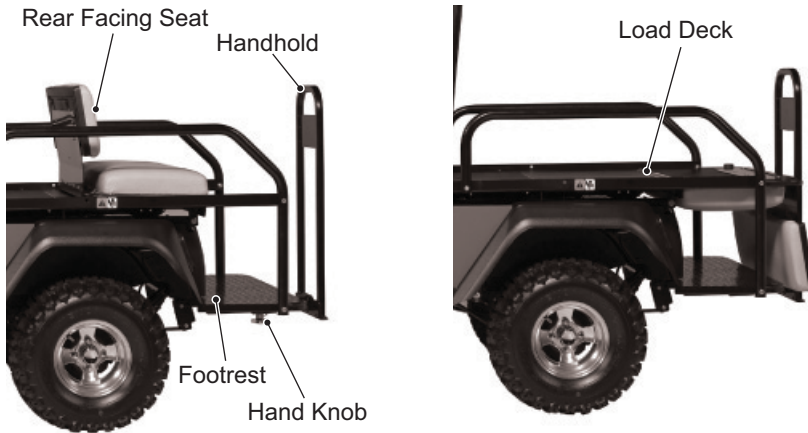

Canopy Top and Windshield

⚠ WARNING

The canopy top does not provide protection from rollover or falling objects.

The windshield does not provide protection from tree branches or moving objects.

⚠ CAUTION

To prevent damage to the vehicle, do not hold on to the canopy top struts.

The canopy top and windshield provide some protection from the elements, but do not keep the operator and passenger dry in heavy rain.

This vehicle is not equipped with seat belts, and the canopy top is not designed to provide rollover protection. In addition, the canopy top does not protect against falling objects, nor does the windshield protect against flying objects and tree limbs.

FEATURES AND CONTROLS

OPERATION

SAFETY

WARNING Failure to operate the vehicle correctly can result in a collision, loss of control, accident or rollover, and cause serious injury or death. Follow all operation procedures in this section of the manual. Read and comply with all safety warnings in the safety section of this owner's manual.

BEFORE INITIAL USE

To prepare your new vehicle for operation, complete the following:

- Remove the protective plastic from the seats.
- Check for possible leaks that may have developed during shipment of the vehicle.

WARNING Explosive hydrogen gas is created during the charge cycle of the batteries. Good ventilation is necessary to remove gas from enclosed spaces. The air must change every 12 minutes.

Never charge a vehicle near flammable materials, open flame or sparks. Never charge a vehicle near gas water heaters and furnaces.

- Charge the batteries.
- Perform the following pre-ride inspection.

PRE-RIDE INSPECTION

Inspect and verify that the vehicle is in safe operating condition before each use to decrease the risk of an accident. Check the items in the table to help ensure safe and reliable operation.

Item	Check	Page
Batteries	Check charge level.	
Brake system/pedal travel	Check for proper operation.	47
Parking brake	Ensure vehicle does not roll when the parking brake is engaged.	
Front suspension	Inspect. Lubricate if necessary. Check for loose or missing hardware.	
Rear suspension	Inspect. Lubricate if necessary. Check for loose or missing hardware.	
CV boots	Inspect for damage. Replace if necessary.	
Steering	Check for smooth and free operation.	
Tires	Check condition and pressure.	12, 44
Wheel hardware	Check for loose or missing hardware.	
Frame hardware	Check for loose or missing hardware.	
Fluid leakage	Inspect vehicle for leaks.	
Switches	Check operation.	
Reverse warning alarm	Check operation.	
Headlights	Check operation.	45
Brake light / taillights	Check operation.	45

OPERATION

ENVIRONMENTAL AWARENESS

WARNING

When driving the vehicle, be careful of potential environmental hazards like steep slopes, rocks, tree branches, etc. that could cause an incident that could result in vehicle damage, personal injury or death.

CAUTION

There is a risk of fire when the vehicle is operated near combustible material.

Always be respectful of the environment.

Respect all wildlife and their habitat.

Respect private property and comply with all local laws and regulations governing the use of light duty utility vehicles.

Make sure you are permitted by property owners to operate the vehicle on their property.

If operating your vehicle on private property, obtain permission from the owner prior to entering their property.

CHARGER

Both off board and on board chargers should be operated in accordance with the charger manufacturer's instructions. An on board charger is standard equipment on this vehicle. If the off board charger option has been selected, be sure to retain and follow the operation instructions supplied with the charger. Always place the off board charger outside the vehicle before and during the charging cycle. Never charge batteries in a hazardous environment.

DANGER

Risk of electric shock. Connect the charger power cord to an outlet that is correctly installed and connected to an electrical ground according to all codes and regulations. A grounded outlet is necessary to decrease the risk of electric shock – do not use ground adapters or replace the plug. Do not touch parts of output connector or battery terminals that do not have insulation.

Disconnect the DC plug before you make or break the connections to a battery that is charging. Do not open or disassemble the charger. Do not operate the charger if the AC cord is damaged. Make sure qualified personnel does all repair work to the charger.

Refer to APPENDIX A for the charger manufacturer User's Guide for operating instructions, maintenance instructions and troubleshooting instructions.

On Board Charger

WARNING

To prevent over-heating that can cause damage to the charger and possible fire, keep the air fins clear. Install portable chargers on a platform above the ground to allow maximum air flow around and below the charger.

The power AC cord has a plug with a ground post. Do not remove, cut or bend the ground post.

The on board charger is located under the driver side load bed. It is wired directly to the batteries. Before charging the batteries, park the vehicle in a well ventilated area, engage the parking brake, turn key switch to OFF and remove key. Plug charger cord into a dedicated 15 amp AC outlet to activate the charger. When the charging cycle is complete, unplug the charging cord.

PERFORMANCE FEATURES

NOTICE: *The vehicle operates when the Run/Tow switch is in the RUN position.*

The speed of the motor is sensed and controlled by the controller.

Speed Control



The speed control system is not an alternative for the brake. Use the brake to control speed and decrease the risk of injury.

Speed control system vehicles are equipped with a regenerative motor control system.

Example: If all of the following events occur:

- the vehicle is being driven down a slope
- the vehicle attempts to exceed the specified top speed with the accelerator pedal pressed **or** released

the regenerative brake will limit the speed of the vehicle to the specified top speed but the warning beeper will **not** activate. When the regenerative braking system is activated by this sequence of occurrences, the motor generates power which is returned to the batteries.

If the operator tries to override the electronic brake feature by moving the direction selector or key switch to another position, the warning beeper activates and the vehicle brakes **quickly** until it reaches approximately 2 mph (3 kph).

Pedal-Up Braking

Pedal-up braking is regenerative braking that occurs when the accelerator pedal is released while the vehicle is moving between 8 mph (13 kph) and the vehicle's top speed.

Example: If all of the following events occur:

- the vehicle is being driven down a slope
- the accelerator pedal is released for more than one second

the pedal-up braking decreases speed to 8 mph (13 kph), then the vehicle freely moves without the accelerator pressed, between 8 and 3 mph (5 kph), or the accelerator pedal is applied. The warning beeper will **not** activate. When pedal-up braking is activated by this sequence of occurrences, the motor generates power which is returned to the batteries.

Walk-Away Feature

Walk-Away limits vehicle movement without driver input, decreases vehicle speed to 2 mph (3 kph) and activates an alarm (reverse beeper).

Example: If all of the following events occur:

- the vehicle is stopped for more than 1.5 seconds
- the accelerator pedal is released for more than one second
- the vehicle starts to move at more than 2 mph (3 kph)

the Walk-Away feature limits speed to approximately 2 mph (3 kph) and the warning beeper activates. When the accelerator pedal is pressed, the Walk-Away feature and warning beeper stops and normal vehicle operation continues.

Anti-Roll Back Feature

Anti-Roll Back, like Walk-Away, limits reverse motion of the vehicle down a slope to less than 2 mph (3 kph). See Walk-Away Feature for more information.

Anti-Stall Feature

Anti-Stall protection prevents motor damage if the vehicle is stalled against an object or on a hill.

Example: If all of the following events occur:

- the system senses that the accelerator pedal is pressed (power applied to motor)
- the motor is stopped long enough that additional time can cause damage to the motor

the Anti-Stall feature will interrupt power to the motor. This short interruption allows the vehicle to move backward slightly before it stops again. The procedure will repeat at intervals until the vehicle is moved from the stopped condition.

Example: If all of the following events occur:

- the system senses that the accelerator pedal is pressed (power applied to motor)
- the brake is engaged to prevent vehicle motion

OPERATION

the Anti-Stall feature senses a stalled motor condition and removes power from the motor. When the brake pedal is released, the vehicle will move backward slightly before power is returned to the motor.

High Pedal Disable Feature

High Pedal Disable prevents acceleration of the vehicle if the direction selector is changed or the key is turned on while the accelerator is pressed.

Diagnostic Mode Feature

Diagnostic mode helps with troubleshooting.

With some electrical system failures, the Diagnostic Mode feature defaults to a mode that allows the vehicle to operate at a decreased speed.

This feature allows you to return the vehicle to the storage facility and identify the problem.

The technician can put the controller in diagnostic mode and the controller identifies the failure mode.

STARTING AND STOPPING THE VEHICLE

⚠ WARNING Unintentional roll-back of the vehicle could cause severe personal injury or vehicle damage. To reduce the possibility of vehicle roll-back, keep the brake fully pressed until the motor has started.

All vehicles have an *interlock* system that disables the controller and prevents operation or tow of the vehicle while the charger is connected. Remove the charger plug from the receptacle and correctly store the cable before you move the vehicle.

1. Sit in the driver's seat.
2. Press and hold the brake pedal.
3. Insert the key and turn to the ON position.
4. Move the direction selector to the appropriate position.

NOTICE: When the direction selector is moved to the reverse position, a warning alarm will activate to indicate that the vehicle is ready to run in reverse.

5. Slowly press the accelerator pedal to start the motor.
6. When the accelerator pedal is released, the motor decreases the speed of the vehicle. To stop the vehicle more quickly, press the brake pedal.
7. Engage the parking brake and remove the key from the switch before exiting the vehicle.

Starting on a Hill

⚠ WARNING Unintentional roll-back of the vehicle could cause severe personal injury or vehicle damage. To reduce the possibility of vehicle roll-back, keep the brake fully pressed until the motor has started.

⚠ CAUTION Do not use the accelerator and motor to hold the vehicle on a hill. Doing so for more than 3 - 4 seconds will cause permanent damage to motor.

To decrease the risk of permanent damage to the drive system, do not allow roll-back when you start the vehicle on a hill.

1. Press the brake pedal with your left foot when releasing the parking brake. Keep pressure on the pedal to prevent the vehicle from rolling back.
2. Press the accelerator pedal with your right foot as you release the brake pedal.
3. Press the accelerator pedal with gradual and steady pressure until the vehicle reaches the desired speed.

ACCELERATING

⚠ WARNING Accidental movement of the accelerator pedal can cause the vehicle to suddenly move and cause severe injury or death.

Make sure the key is in the OFF position and the parking brake is engaged any time the vehicle is parked.

1. Release the parking brake.
2. Move the key switch to the ON position.

3. Apply slow, steady pressure to the accelerator pedal to increase vehicle speed. When you release the accelerator pedal, the motor decreases the speed of the vehicle.

NOTICE: *On mechanical brake vehicles, if the key switch is in the ON position and the parking brake is engaged, the brake releases when you press the accelerator pedal and can cause the vehicle to move suddenly. This is a feature to make sure the vehicle is not driven with the parking brake engaged. Pressing the accelerator pedal is not the recommended method to release the parking brake.*

BRAKING

WARNING

When carrying cargo or towing a trailer, the weight of the load will increase the braking distance required to slow or stop the vehicle. Not allowing for increased braking distance under load can cause an accident or injury.

1. Release the accelerator pedal completely.

NOTICE: *Pressing the top section of the brake pedal engages the parking brake.*

2. Press the brake pedal to slow vehicle speed or stop the vehicle completely.
3. Practice slowing and stopping using the brake to become familiar with the controls.

Coasting

WARNING

Do not allow the vehicle to coast at above recommended speeds. Control vehicle speed with the brake.

The vehicle has a braking feature (pedal-up) that decreases the speed when the accelerator pedal is released. The feature continues to decrease the speed until the vehicle stops. Press the brake if you need to decrease speed or stop the vehicle quickly.

DRIVING PROCEDURE

1. Perform the pre-ride inspection. See page 23.
2. Sit in the driver's seat.
3. Check surroundings and determine the path of travel.
4. Press the brake pedal and release the parking brake.
5. Insert the key and turn to the ON position.
6. Move the direction selector to the appropriate position.
7. With both hands on the steering wheel, release the brake and immediately start to apply gradual and steady pressure to the accelerator pedal.
8. Practice maneuvering the vehicle using the accelerator and brake pedals. Drive slowly and cautiously until you are comfortable with the controls.
9. Do not drive with a passenger until you have at least two hours of experience driving this vehicle.

Coasting

WARNING

Vehicle speed can increase quickly when driving downhill. Allowing the vehicle to coast downhill at high speeds can cause loss of control and result in severe injury or death. Limit your vehicle speed by pressing the brake.

Do not allow the vehicle to coast at speeds that are above the maximum recommended speed. Apply constant brake pressure when descending a hill to control the speed of the vehicle.

DRIVING WITH A PASSENGER

- All passengers must be at least 59 in. (150 cm) tall. Passengers must be able to sit with their back against the seat, both feet on the floor.
- Do not allow more than one passenger in the vehicle with a truck bed. If equipped with a rear facing seat, do not allow more than one passenger on the front seat and two passengers on the rear facing seat.
- Do not allow a passenger to ride anywhere on the vehicle except the passenger seat.
- Travel at speeds appropriate for your skills, your passenger's skills and the operating conditions. Avoid unexpected or aggressive maneuvers that could cause discomfort or injury to the passenger.

OPERATION

- Handling characteristics can change with the added weight of a passenger. Allow more time and distance for braking.

SLIPPERY SURFACES

⚠ WARNING Skidding or sliding can cause loss of control. Skidding or sliding can cause rollover if tires have lost traction, then regain traction suddenly. When operating on slippery surfaces, travel at reduced speed to help maintain control of the vehicle.

When operating in conditions such as ice, water, muddy trails, loose gravel or freezing temperatures, follow these guidelines:

- Do not operate on excessively rough, slippery or loose terrain.
- Slow down before entering potentially slippery areas.
- Maintain a high level of alertness, carefully evaluate the path of travel and avoid quick, sharp turns.
- Correct a skid by turning the steering wheel in the direction of the skid. *Never apply the brakes during a skid.*

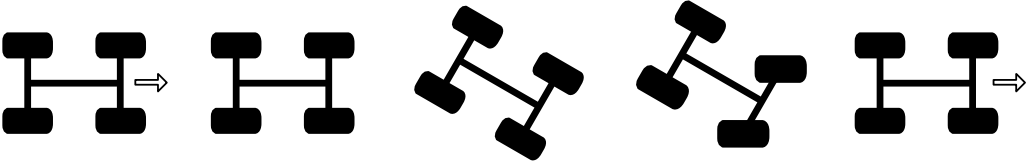

DRIVING UPHILL

When driving up a hill, follow these guidelines:

- Drive straight up the hill.
- Avoid excessively steep hills.
- Keep both feet on the floor or pedals.
- Check the terrain before driving up a hill. Do not try to climb hills that have excessively slippery or loose surfaces.
- Drive at a steady rate of acceleration and speed.
- Do not drive over the crest of a hill at high speed. An obstacle, sharp drop, or another person or vehicle could be on the other side of the hill.
- Do not attempt to drive up a hill that is beyond your skill level.

TRAVERSING HILLSIDES

Traversing a hillside is not recommended. Improper procedure can cause loss of control or a rollover. Avoid crossing the side of a hill unless absolutely necessary. If traversing a hillside is unavoidable, check the terrain and determine if it can be accomplished safely. Do not proceed if the terrain is beyond the vehicle or driver's ability.

If traversing a hillside is unavoidable, follow these guidelines:

- Drive slowly.
- Use extreme caution.
- Avoid crossing the side of a hill that has a slippery surface.
- Avoid crossing the side of a steep hill.
- When traversing a hillside that has soft terrain, it may be necessary to steer slightly uphill to keep the vehicle traveling in a straight line.
- If you feel that you are losing control of the vehicle, steer downhill if possible to regain control.

DRIVING DOWNHILL

⚠ WARNING When carrying cargo or towing a trailer, the weight of the load will increase the braking distance required to slow or stop the vehicle. Not allowing for increased braking distance under load can cause an accident or injury.

When driving down a hill, follow these guidelines:

- Avoid excessively steep hills.
- Check the terrain carefully before descending any hill.

- Never drive down hills with excessively slippery or loose surfaces.
- Drive slowly.
- Drive straight down the hill. Avoid descending the hill at an angle that could cause the vehicle to lean sharply to one side.
- Apply light and constant pressure to the brakes to maintain slow speed and control of the vehicle.

STALLING ON A HILL

A rollover can result from stalling or rolling backward while climbing a hill. Drive uphill at a constant speed.

If your vehicle completely stalls while climbing a hill:

1. Apply the brakes.
2. Verify that the area behind you is clear.
3. Put the transmission in R (reverse).
4. Use steady brake pressure to control speed, and allow the vehicle to slowly roll straight downhill.

If your vehicle begins to roll downhill:

1. Do not press the accelerator.
2. Apply the brakes gradually until the vehicle fully stops.
3. Verify that the area behind you is clear.
4. Put the transmission in R (reverse).
5. Use steady brake pressure to control speed, and allow the vehicle to slowly roll straight downhill.

DRIVING IN REVERSE

When driving in reverse, follow these guidelines:

- Check that the area behind the vehicle is clear of obstacles and people.
- Check left and right fields of vision before driving in reverse.
- Do not back down a steep hill.
- Drive in reverse slowly.
- Press the brakes lightly for stopping.
- Accelerate slow and steady.
- Avoid turning at sharp angles.

PARKING THE VEHICLE

NOTICE: When parking the vehicle inside a garage or structure, the space must be well ventilated. Park the vehicle away from any source of flame or sparks, including any appliance with a pilot light.

Park the vehicle on a flat surface if possible. If parking on an incline is unavoidable, be sure to chock the wheels as shown in the following illustration to keep the vehicle from rolling.

1. Press the brake to stop the vehicle.
2. Engage the parking brake.
3. Turn the key switch to OFF.
4. Remove the key from the ignition to prevent unauthorized use.
5. If parking on an incline, chock the wheels on the downhill end as shown in the following illustration.

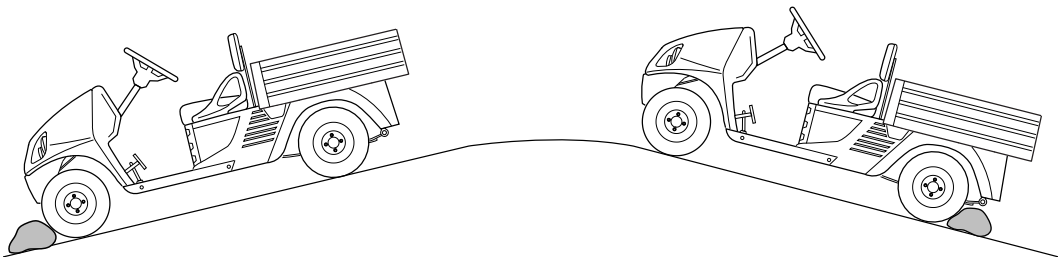

OPERATION

HAULING CARGO

WARNING

Hauling cargo incorrectly can alter vehicle handling characteristics and cause loss of control, brake instability, and possibly lead to serious injury or death.

Never exceed the maximum weight capacity of the vehicle. The total load (operator, passenger, accessories, cargo and load on hitch) must never exceed the maximum weight capacity of the vehicle. See the chart in *Maximum Cargo Load / Maximum Weight Capacity* on page 30.

Position the load as far forward, and as low as possible in the truck bed.

Secure all loads before operating. Unsecured loads can shift and create unstable operating conditions.



Operating the vehicle with passengers in the truck bed can result in severe injury or death. Never allow a passenger to ride in the truck bed. Passengers must always ride seated in the passenger seat.

Drive slowly and carefully.

Operate only with stable and safely arranged loads. When handling loads that are impossible to center in the truck bed, make sure the load is secured as tightly as possible and operate the vehicle with extra caution.

Always attach a tow load to the rear hitch of the vehicle.

Reduce speed and allow greater distances for braking when hauling cargo.

Heavy loads affect braking and handling characteristics. Use extra caution when applying brakes with a heavily loaded vehicle. Avoid terrain or situations that may require reverse downhill travel.

Use extra caution when operating with loads that extend over the truck bed sides. Stability and maneuverability can be affected and increase risk of rollover.

This vehicle is designed to carry or tow specific capacities. Read and comply with the load distribution warnings on the warning label affixed to the bed. The total load (operator, passenger, accessories, cargo and load on hitch) must never exceed the maximum weight capacity of the vehicle.

Maximum Cargo Load / Maximum Weight Capacity

Maximum Cargo Load Capacity	500 lbs. (227 kg)
Maximum Vehicle Weight Capacity	900 lbs. (408 kg)
Maximum Load Deck Capacity (If equipped with rear facing seat)	250 lbs. (110 kg)

- Do not exceed the maximum cargo load capacity.
- Do not exceed the maximum vehicle weight capacity (includes weight of operator, passenger, cargo and accessories).

Flip Seat/ Load Deck Operation (If Equipped)

WARNING To reduce the possibility of severe injury or death never operate vehicle without the rear handhold installed in the proper position. When rear seat is used the handhold must be positioned in the setting closest to the footrest and secured with the hand knob.

Some vehicles are equipped with a rear facing seat that pivots to form a load deck. The rear facing seat is for a maximum of two passengers. The seat can be converted into a load deck.

WARNING Only two passengers allowed on the rear facing seat. Never leave small children alone on the seat. Keep arms and legs inside the vehicle boundary at all times.

When used for passengers, the handhold must be put in the position closest to the rear footrest. The hand knob must be installed to secure the handhold in place.

To change from passenger seating to a load deck follow the steps below:

- Loosen the hand knob under the footrest.
- Slide the handhold away from the vehicle. DO NOT remove the handhold from the vehicle.
- Rotate the seat back and seat bottom toward the rear of the vehicle. The seat bottom board will rest in the two side frame pieces.
- Make sure the handhold is adjusted so the hand knob can be tightened. DO NOT remove the handhold from the vehicle.
- Tighten the hand knob to secure the handhold in place.

WARNING To reduce the possibility of severe injury or death DO NOT carry passengers on the load deck.

To change from a load deck to passenger seating follow the steps below:

- Loosen the hand knob under the footrest. DO NOT remove the handhold from the vehicle.
- Slide the handhold away from the vehicle. DO NOT remove the handhold from the vehicle.
- Rotate the seat back and seat bottom toward the front of the vehicle.
- Slide the handhold to the position closest to the footrest.
- Make sure the handhold is adjusted so the hand knob can be tightened.

Tighten the hand knob to secure the handhold in place.

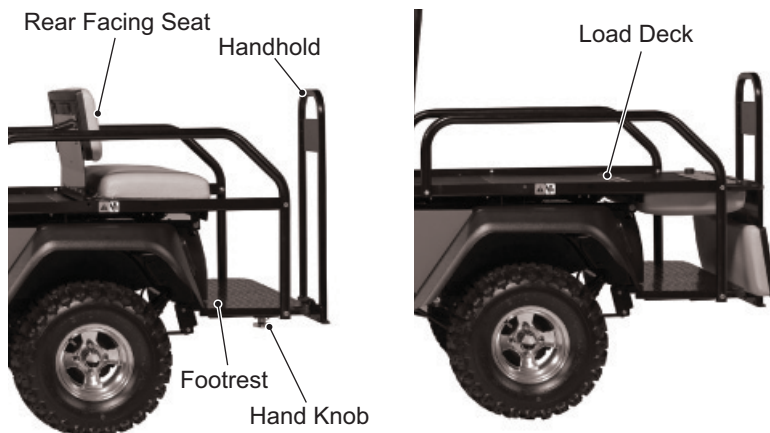

OPERATION

TRUCK BED OPERATION

⚠ WARNING

Failure to follow these instructions can cause personal injury, damage the vehicle or cause the vehicle to tip over. Be aware of the load when you operate the vehicle. Read, understand and follow the warning label attached to the front of the truck bed.

Do not allow passengers to ride in the truck bed. A sudden move or stop can cause severe injury or death to passengers in the truck bed.

Before operating, make sure the area behind the vehicle is clear.

Load Bed (P/N 74821G01)

Located on the truck bed.

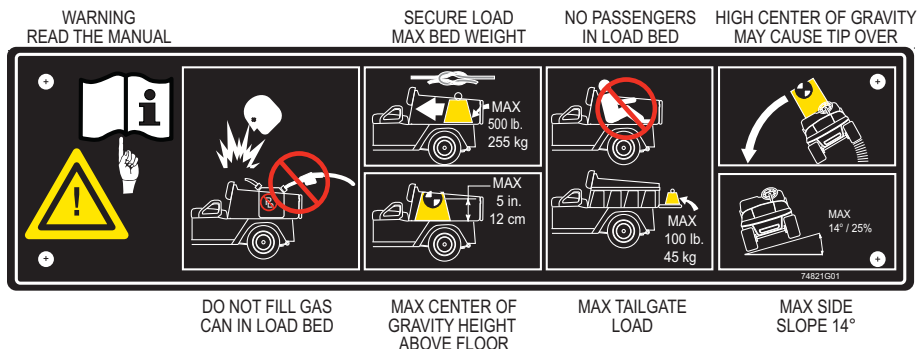

A truck bed warning label is attached to the inside front of the truck bed. Understand and comply with the warnings on this label for safe operation of the vehicle.

- See the truck bed warning label for maximum load.
- Position the load in the truck bed as far forward as possible.
- Make sure the center of gravity of the load is within the height limit shown on label.
- Secure the load to the truck bed.
- Be aware of the load when you operate the vehicle.
- Do not let passengers to ride in the truck bed. Do not drive the vehicle with the truck bed lifted or with the tailgate unsupported.

⚠ WARNING

Never fill a gas container in the truck bed. Static discharge can ignite gasoline vapor and cause an explosion.

Always put the gas container on the ground before you fill with gas. Never fill a gas container in the truck bed. Static electricity is built up during the fueling process and can discharge and cause the gasoline vapor to ignite.

DUMPING THE TRUCK BED

⚠ WARNING

If the bulk of the cargo weight is at the rear of the bed, the bed may unexpectedly dump when the release lever is pulled and cause serious injury to anyone close by. Never pull the release lever unless the load is positioned evenly or located at the front of the truck bed.

Never leave the truck bed in the upright position after emptying the cargo. The bed can unexpectedly close and cause serious injury. Never drive the vehicle with the truck bed in the raised position.

1. Select a level location to dump the truck bed load. Do not attempt to dump or unload the vehicle if it is on an incline.
2. Apply the brakes and engage the parking brake on vehicles with mechanical brakes.

3. Put the direction selector in forward (F).
4. Exit the vehicle.
5. Make sure the cargo is positioned evenly or located at the front of the truck bed.
6. Release the tailgate latches.
7. Manual bed lift vehicles:
 - a. Stand clear and pull the release handle. Lift up on the truck bed to dump the cargo.
 - b. When the truck bed is empty, lower the bed back into place.
 - c. Push down to latch the bed.
- Electric lift vehicles:
 - a. Press the top of the switch to activate the electric lift and raise the bed.
 - b. Press the bottom of the switch to lower the bed back into place.
8. Close and latch the tailgate.

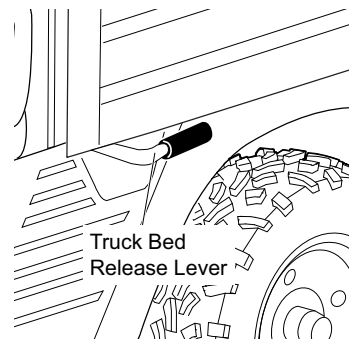

TOWING

NOTICE: Vehicles must be equipped with a rear hitch to tow a load.



WARNING Attach a trailer to the tow hitch only. Attaching the trailer at any other location can cause loss of vehicle control.

Do not attach baskets or extensions to the hitch receiver. These types of items change the performance qualities of the vehicle and cause dangerous handling characteristics, possible rollover or vehicle damage.

When towing a load, follow these guidelines:

- Do not tow more than the recommended towing weight for the vehicle. See the following table and the *VEHICLE SPECIFICATIONS* on page 51.

VEHICLE LOADING	MAX. WEIGHT
Occupant Capacity	400 lbs. (181.4 kg)
Cargo Capacity	500 lbs. (226.8)
Vehicle Rated Capacity = Occupant + Cargo	900 lbs. (408.2 kg)
VEHICLE WEIGHT	
Curb Weight (includes fuel)	1513 lbs. (686.3 kg)
Gross Weight = Curb Weight + Rated Capacity	2413 lbs. (1094.5 kg)
VEHICLE TOWING (0% - 20% GRADE)	
Maximum Trailer Tongue Weight	150 lbs. (68 kg)
Maximum Gross Trailer Weight	1200 lbs. (544.3 kg)
Maximum Vehicle Combined Towing Weight = Curb Weight + Rated Capacity + Trailer	2713 lbs. (1233.2 kg)
Maximum Vehicle Drawbar (Level Ground & Improved Surfaces)	930 lbs. (4173 N)

- The total capacity of the vehicle, operator, passenger, load bed contents and accessories must be reduced to compensate for the trailer and load.
- The range of motion of the trailer is limited by the ball and hitch. Do not tow a trailer on rough terrain.
- Drive slowly and carefully.
- Towing a load increases braking distances required for slowing or stopping the vehicle.
- Do not attach baskets or extensions to the hitch receiver.
- Avoid parking on an incline.
- Do not operate on a grade exceeding 20%.
- Always secure the cargo.



WINCH

The safety warnings and information in this section apply if your vehicle has a winch.

WARNING

Improper or irresponsible use of the winch can result in severe injury or death. Always follow all winch instructions and warnings in this manual.

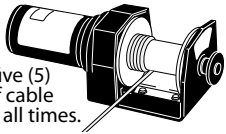
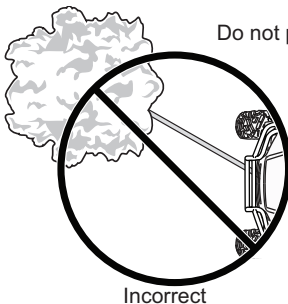
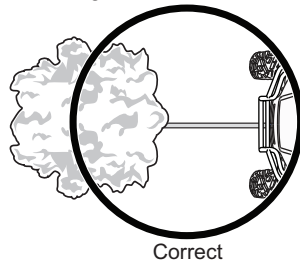
WINCH SAFETY

- Read and understand this entire section before operating your winch.
 - Inspect your winch and winch cable for damage before each use.
 - Never use alcohol or drugs before or during operation of the winch.
 - Do not allow any person below the age of 16 to operate the winch.
 - Always wear eye protection and heavy gloves while operating the winch.
 - Always keep body, hair, clothing and jewelry clear of the winch cable and hook while operating the winch.
 - Never attempt to jerk a load attached to the winch with a moving vehicle. See *Shock Loading* on page 38.
 - Always keep the area around the vehicle, winch, winch cable and load clear of people and distractions while operating the winch.
 - Always turn the vehicle ignition switch OFF when the vehicle and winch are not being used.
 - Maintain at least five full turns of winch cable wrapped around the winch drum at all times. The friction provided by the wrapped cable allows the drum to pull on the winch cable and move the load.
- 
- Minimum five (5) full turns of cable on drum at all times.
- If pulling yourself, put your vehicle in N (neutral). If pulling something else, put your vehicle in P (park) to prevent it from moving while winching. Use wheel chocks if needed.
 - Always align the vehicle and winch with the load directly in front of the vehicle as much as possible. Avoid winching with the winch cable at an angle to the vehicle's centerline whenever possible.
 - If winching at an angle is unavoidable, follow these precautions:
 - Be observant of the winch drum. Do not allow the winch cable to stack or accumulate at one end of the winch drum. If the winch cable stacks, damage to the winch and winch cable can occur.
 - If stacking occurs, stop winching. Follow step 13 on page 37 to feed and rewind the cable evenly before continuing the winch operation.
 - Never winch up or down at sharp angles. It can destabilize the winching vehicle and possibly cause unexpected movement.
 - Never winch loads that exceed the rated capacity of the winch.
 - The winch motor can become hot during use. After winching for more than 45 seconds, or if the winch stalls during operation, stop winching and allow the winch motor to cool down before using it again.
 - Never touch, push, pull or straddle the winch cable while winching a load.
 - Even if wearing heavy gloves, never let the winch cable run through your hands.
 - Never release the clutch on the winch when the winch cable is under load.
 - Never use the winch for lifting or transporting people.
 - Never use the winch to hoist or suspend a vertical load.
 - Never immerse the winch in water. Take your winch to your dealer for service if immersion occurs.
 - Never winch the hook fully into the winch. It can damage winch components.
 - Disconnect the remote control from the vehicle when the winch is not in use to prevent accidental activation and use by unauthorized persons.
 - Never apply grease or oil to the winch cable. Grease and oil will cause the winch cable to collect debris and shorten the life of the cable.
- Do not pull at an angle.
- 
- Incorrect
- 
- Correct
- 

WINCH

WINCH OPERATION

Read all of the *Winch Safety* beginning page 35 before operating your winch.

NOTICE: *Practicing operation and use of the winch before it is needed to perform a job is recommended.*

WARNING Improper or irresponsible winch use can result in severe injury or death. Comply with all winch instructions and warnings in this manual.

Since all winching situations are different, follow these important guidelines:

- Evaluate the winching operation you are about to perform.
- Proceed slowly and deliberately.
- Maintain constant awareness of your surroundings.
- Maintain constant awareness that your winch is very powerful.
- Change your winching strategy if what you are doing is not working.
- Seek assistance if needed.

1. Inspect the vehicle, winch, winch cable and winch controls for any signs of damage or parts in need of repair or replacement before each use. Replace the cable if signs of wear or damage is visible. Never operate a winch in need or repair or service.
2. If pulling yourself, put your vehicle in N (neutral). If pulling something else, put your vehicle in P (park) to prevent it from moving while winching. Use wheel chocks if needed.
3. Use a hook strap when handling the hook.

WARNING Never put your fingers into the hook. Doing so could lead to severe injury.

- a. Attach the hook onto the load or use a tow strap or chain to secure the load to the winch cable.

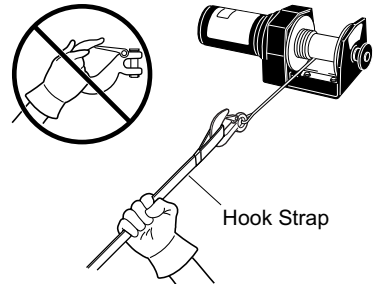

WARNING Do not use a recovery strap as a tow strap. Recovery straps are designed to stretch so they store energy. The stored energy in the recovery strap will release if the winch cable breaks. The use of recovery straps can cause severe injury or death.

Do not hook the winch cable back onto itself. Doing so will damage the winch cable and can result in winch cable failure.

Replace the winch cable at the first sign of damage to prevent severe injury or death in the event of failure. Replace factory approved replacement parts.



- b. If possible, keep the winch cable aligned with the centerline of the winching vehicle to help maintain even spooling of the winch cable.
- c. If freeing a stuck vehicle by attaching to a tree, use an item such as a tow strap to avoid damaging the tree during winch operation. Sharp cables and chains can damage or kill trees.
- d. The safety latch on the winch cable hook must be fully seated when the load is attached.

Correct

Incorrect

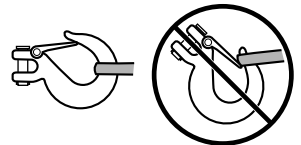

- e. Never operate the winch with a damaged hook or latch. Damaged parts must be replaced before winch operation.

4. Never remove the hook strap from the hook until the operation is complete.
5. Release the winch clutch and pull out the winch cable.

6. Pull out as much cable as possible to maximize the winch's pulling capacity. Maintain at least five full turns of winch cable wrapped around the winch drum at all times. The friction provided by the wrapped cable allows the drum to pull on the winch cable and move the load.

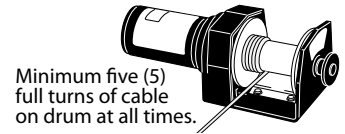

7. Read and follow the information below for winch damping to ensure safe winch use.

- a. To absorb energy that could be released by a winch cable failure, always put a damper on the winch cable. A damper can be a heavy jacket, tarp or other soft, dense object. A damper can absorb much of the energy released if the winch cable breaks when winching. Use of a tree limb can help as a damper if no other items are available.
- b. Lay the damper on top of the mid-point of the winch cable length that is spooled out.
- c. On a long pull, it may be necessary to stop winching and reposition the damper so that it is always near the mid-point of the cable. Always release the tension on the winch cable before repositioning the damper.
- d. Never stand in direct line with the winch cable. Never allow others to stand near or in line with the winch cable during winch operation.

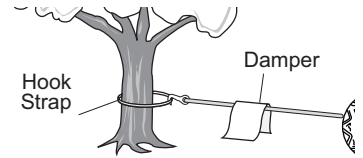

8. Never use damaged or worn straps, chains or other rigging items.
9. The only time a winch-equipped vehicle should be moving when the winch is in use is when the winching vehicle itself is stuck. Follow these guidelines when winching a stuck vehicle.
 - a. Release the winch clutch and spool out the necessary length of winch cable.
 - b. Align the cable as close as possible to the winching vehicle centerline.
 - c. Attach the cable hook to the anchor point or the stuck vehicle frame.
 - d. Re-engage the clutch on the winch.
 - e. Slowly winch in cable slack.
 - f. Shift the stuck vehicle to the lowest gear available.
 - g. Slowly and carefully press the accelerator pedal and winch together to free the vehicle.
 - h. Stop winching as soon as the stuck vehicle is able to propel itself without the help of the winch.
 - i. Remove the cable hook.
 - j. Rewind the cable evenly back onto the drum.
10. To prevent damage to the vehicle, do not attempt to winch another stuck vehicle by attaching the cable to a suspension component, brush guard, bumper or cargo rack. Always attach the cable to the vehicle frame or hitch.
11. Extensive winching will drain the battery on the winching vehicle. If winching for long periods of time, allow the engine to run while operating the winch to prevent battery drainage.
12. The winch motor can become hot during use. After winching for more than 45 seconds, or if the winch stalls during operation, stop winching and allow the winch to cool down for 10 minutes before using it again.
13. If it is necessary to redistribute the winch cable on the drum after winching in complete, use the following procedure:
 - a. Find an assistant to help.
 - b. Release the clutch on the winch.
 - c. Pull the cable out.
 - d. Re-engage the clutch.
 - e. Have the assistant pull the winch cable tightly with about 100 lbs. (45 kg) of tension using the hook strap.
 - f. Slowly retract the cable while the assistant moves the end of the cable back and forth horizontally to evenly distribute the cable on the drum. This process reduces the chance of the cable wedging itself between lower layers of the cable.

WINCH CABLE CARE

For your safety, use factory approved replacement parts.



WARNING

Replace the winch cable at the first sign of damage to prevent severe injury or death in the event of failure.

WINCH

- Always inspect the winch cable before each use. Inspect for wear or kinks in the cable.
 - A kinked winch cable made of wire rope is shown at right. Even after being straightened out, this cable has been permanently and severely damaged. Discontinue use of a cable in this condition.
 - A winch cable made of synthetic rope should be inspected for signs of fraying. Replace the cable if fraying is visible.
 - Inspect the winch cable for fused or melted fibers, indicated by stiffness and a smooth or glazed appearance. Discontinue use of a winch cable in this condition.

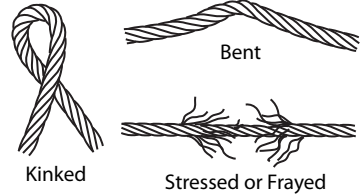

SHOCK LOADING

The winch cable is designed and tested to withstand the loads produced by the winch motor when operated from a stationary vehicle. The winch and winch cable are not designed for shock loading.

Practices that produce shock loading on a winch cable include:

- Abrupt acceleration of the vehicle against the pull of the winch cable, which causes immediate force on the winch cable that exceeds the force the cable is designed to withstand.
- Jogging the winch by quickly turning the winch ON and OFF repeatedly, which puts extra load on the winch, winch cable and generates excessive heat from the motor.
- Using the winch to tow vehicles or other objects.

WARNING

A winch cable is not designed for shock loading. Shock loading can tension a cable beyond its strength and cause it to break. A broken winch cable under high loading conditions can cause severe injury or death to anyone in the area.

When using the winch, use the following guidelines:

- To avoid generating high winch cable loads that may exceed the strength of the cable:
 - Never use the winching vehicle to take up slack in the winch cable by moving the vehicle.
 - Never use the winching vehicle to move the object being winched; use the winch only.
- Never jog the winch (quickly turn the winch ON and OFF repeatedly).
- Never tow a vehicle or other objects with a winch. Towing an object with a winch produces shock loading of the cable even when towing at low speeds. Towing from a winch also positions the towing force high on the vehicle and cause instability of the vehicle.
- Never use recovery straps with your winch. Recovery straps are designed to stretch, so they store energy. The stored energy in the recovery strap will release if the winch cable breaks. The use of recovery straps can cause severe injury or death.
- Never use the winch as a tie down to secure a vehicle to a trailer or other transportation vehicle. Using a winch as a tie down can also cause shock loading that can damage the winch, winch cable or vehicles.

WINCH MAINTENANCE SAFETY

WARNING

Improper or lack of maintenance and service could lead to severe injury or death. Always follow all winch instructions and warnings in this manual.

- Always inspect the winch before each use. Inspect for worn or loose parts including mounting hardware. Never use the winch if any part needs repair or replacement.
- Make sure the winch motor is cool before servicing the winch.
- Always disconnect the battery connections before working on your winch to prevent accidental activation of the winch.
- For your safety, always replace winch parts, including the cable, with factory approved replacement parts.
- Replace the winch cable with one of the exact type.

MAINTENANCE

MAINTENANCE SAFETY



To prevent serious injury or death, follow the procedures and comply with the safety information in this manual while performing vehicle service or maintenance.

Use the tools shown in the tool list and wear the specified safety equipment when performing vehicle service or maintenance.

Remove all jewelry before you service the vehicle.

Do not allow loose clothing or hair to contact the moving parts.

Do not touch hot objects.

Before you disconnect or connect a battery or any other wires, move the run/tow switch to the TOW position and the key switch to the OFF position.

Disconnect the negative battery terminal before you service the vehicle to prevent accidental operation.

The drive wheels must be lifted and supported on jack stands before you do any service to the powertrain when the motor is in operation.

Choke the wheels and support the vehicle with jack stands. NEVER get under a vehicle that is supported by a jack. Lift the vehicle according to the manufacturers instructions.



When you service the vehicle, always wear eye protection. Be careful when working around batteries, using solvents or compressed air.

Use insulated tools within the battery area to prevent sparks or battery explosion.

The electrolyte in a battery is an acid solution which can cause burns to the skin and eyes. Completely clean all electrolyte spills that contact the body and eyes with clear water. Contact a physician immediately.

Neutralize electrolyte spills with a solution of 2 teaspoons (10 ml) sodium bicarbonate (baking soda) mixed in 1 quart (1 liter) of water. Clean with water.

Maintain constant awareness that some components are heavy, spring loaded, corrosive, explosive, can cause high amperage or get extremely hot. Battery acid and hydrogen gas can cause bodily injury. Keep your hands, face, feet and body away from any area that can expose them to injury if an unexpected situation occurs.

After performing maintenance, test the vehicle in a safe area that is free from vehicle and person traffic.

NOTICE: To decrease the risk of damage to the controller or motor, move the run/tow switch to the TOW position before you tow the vehicle.

After you connect a battery or any other wires, wait a minimum of 30 seconds before you move the switch to the RUN position.

To decrease the risk of engine damage, do not operate the vehicle at full throttle for more than 5 seconds if the drive wheels are lifted off the ground.

SCHEDULED MAINTENANCE

Consistent inspection, adjustment and lubrication of some components are necessary to maintain your *vehicle* so that it remains in safe and reliable condition. Refer to the *SCHEDULED MAINTENANCE CHART* on page 40 for detailed requirements.

Inspect, clean, lubricate, adjust and replace parts as necessary. Use *TSV* or equivalent replacement parts.

Record the maintenance items performed along with details in the *MAINTENANCE LOG* beginning on page 57.

NOTICE: Service and adjustments are important for safe and reliable vehicle operation. If not familiar with safe service and adjustment procedures, have your dealer perform the operations.

MAINTENANCE

Severe Use Conditions

Vehicles subjected to heavy or severe use must be inspected and serviced more frequently than those of normal use patterns. The following conditions are considered severe use:

- frequent or prolonged use in a dusty environment
- frequent use in mud, water or sand
- prolonged low speed operation
- short trips in cold weather
- prolonged heavy load operation

SCHEDULED MAINTENANCE CHART

Perform all services at the maintenance interval reached first.

S – Indicates operations that need to be performed on vehicles subjected to severe use.

Item	Interval (perform at interval that comes first)		Remarks	Page
	Hours	Calendar		
Overall vehicle condition	Pre-ride		Inspect.	
Batteries	Pre-ride		Check state of charge, battery condition, loose terminals, corrosion, hold down and hardware.	
Steering	Pre-ride		Check for smooth and free operation.	
Front suspension	Pre-ride		Inspect. Check for leaks and loose or missing hardware.	
Rear suspension	Pre-ride		Inspect. Check for leaks and loose or missing hardware.	
CV boots	Pre-ride		Inspect. Replace as needed.	
Tires	Pre-ride		Check condition and pressure.	12
Wheel lug nuts	Pre-ride		Check for loose or missing.	44
Accelerator	Pre-ride		Check for smooth operation.	47
Brake system	Pre-ride		Check for smooth operation and acceptable stopping distance. Check hydraulic fluid (if applicable).	47
Frame hardware	Pre-ride		Check for loose or missing.	
Headlights and taillights	Pre-ride		Check operation. Replace bulbs as needed.	45
Reverse warning alarm	Pre-ride		Check operation.	
Switches	Pre-ride		Check operation.	
Fluid leakages	Pre-ride		Inspect entire vehicle for leaks	
S Brake pads	10	Monthly	Inspect. Replace as needed.	
Batteries	20	Monthly	Clean.	
Batteries	20	Monthly	Check electrolyte level; fill with water (distilled or purified only) if required.	
Charger receptacle	20	Monthly	Clean connections.	
Parking brake	20	Monthly	Conduct brake performance test; adjust as necessary. Check for correct hold on an incline.	
Accelerator	20	Monthly	Check for smooth operation.	
Wiring	20	Monthly	Inspect for loose connections, broken or missing insulation.	
Steering	20	Monthly	Check for excess play, loose or missing hardware.	
S Tie rods	20	Monthly	Check for excess play, bent rods, loose or missing hardware.	
Front suspension	20	Monthly	Inspect strut for leaks. Check hubs and kingpins, for excessive play, worn bushings, loose or missing hardware.	
Rear axle	20	Monthly	Check for leakage; add oil as required.	

Item	Interval (perform at interval that comes first)		Remarks	Page
	Hours	Calendar		
Brakes	20	Monthly	Check for smooth operation and acceptable stopping distance.	47
Front wheel alignment	60	3 Months	Check for unusual tire wear.	
Rear Suspension	60	3 Months	Check for shock oil leakage, worn bushings, loose or missing hardware.	
S General lubrication	50	3 Months	Lubricate all fittings, pivots, cables, etc. where required.	41
Rear axle	500	5 years	Replace fluid.	
Motor coupling	20,000 Amp Hours	5 years	Add anti-seize compound (approx. 1 tbsp.)	

RECOMMENDED LUBRICANTS AND FLUIDS

Check and lubricate all components at the intervals shown in the *SCHEDULED MAINTENANCE CHART* beginning on page 40.

Item	Capacity	Lubricants/Fluids	Notes
Rear axle oil	12 oz. (1.2 L)	SAE 30	
Grease fittings		Universal joint grease or equivalent	Do not exceed 3 pumps of grease in each fitting.

REPLACEMENT OF MAINTENANCE ITEMS

These items or their equivalents can be purchased through your dealer, directly from TSV or any other qualified source.

Item	Part Number
15 A Fuse	35212G01
LED Headlight Assembly	651411G03
Headlight Bulb	619100
Turn Signal Bulb	619102
Taillight Bulb	21759G1

MAINTENANCE

LIFTING THE VEHICLE

⚠ WARNING

Read and comply with all of the following warnings and lifting procedures to prevent the possibility of the vehicle falling and causing serious injury or death.

For some maintenance procedures, it is necessary to lift the vehicle. Comply with the following warnings and follow the lifting procedure to ensure the safety of you, your vehicle and surroundings.

⚠ WARNING

The vehicle must be on a firm and level surface for lifting.

Remain constantly aware that the vehicle is not stable during the lifting process.

Place the jack and jack stands only in the areas indicated in the following illustration.

Do not get under a vehicle until it's stability on the jack stands is verified; never get under a vehicle while it is on a jack only.

Put wheel chocks in front and behind all wheels that are not being lifted.

Do not allow anyone to remain or get on the vehicle at any time during the lifting process or when the vehicle is lifted.

When performing any service to the drivetrain, lift drive wheels off the ground.

Tools

- jack
- jack stands (4)
- wheel chocks

Lifting Front

1. Chock the rear wheels to keep the vehicle from rolling backward.
2. Put a jack under the center of the front axle.
3. Raise the vehicle with the jack.
4. Install a jack stand under the front frame cross member as shown.
5. Lower the vehicle until it rests on the jack stands.
6. Remove the jack.
7. Confirm that the vehicle is stable on the jack stands before proceeding with any service.

Lifting Rear

1. Chock the front wheels to keep the vehicle from rolling forward.
2. Put a jack under the center of the rear frame cross member.
3. Raise the vehicle with the jack.
4. Install a jack stand under each end of the rear axle.
5. Lower the vehicle until it rests on the jack stands.
6. Remove the jack.
7. Confirm that the vehicle is stable on the jack stands before proceeding with any service.

Lowering Vehicle

1. Make sure chocks are still in place on any wheels that remain on the ground.
2. Put the jack in the same location that was used to raise the vehicle.
3. Raise the vehicle enough to remove the jack stands. Remove the jack stands from underneath the vehicle.
4. Slowly lower the vehicle to the ground and remove the jack.

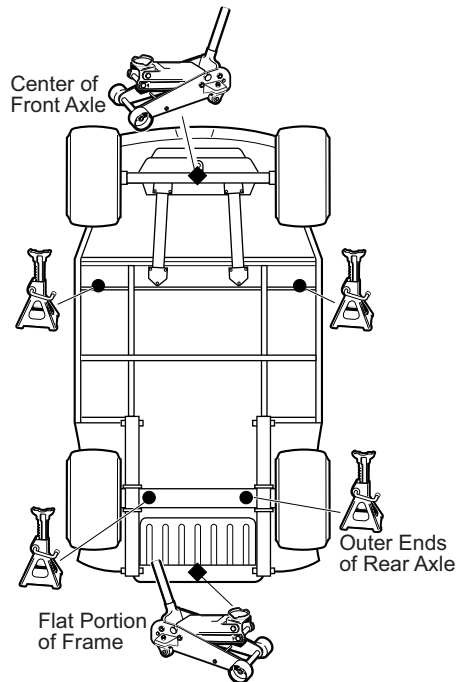

VEHICLE CLEANING AND CARE

Keeping your vehicle clean is not only beneficial to its appearance, but can also help extend the life of various components.

Washing the Vehicle

NOTICE: Do not use a pressure washer to wash your vehicle. High water pressure can damage components.

Some products, including insect repellents and chemicals, will damage plastic surfaces. Do not allow these types of products to contact the vehicle.

- Do not use a pressure washer to clean the vehicle.
- Use an automotive type cleaner or mild soap to wash the vehicle. Harsh cleaners can scratch the finish.
- Use clean or new cloths and pads for washing. Reused cloths and pads can contain dirt particles that will scratch the finish.
- Inspect all grease fittings for dirt intrusion or lack of grease after washing. Apply grease as required to maintain proper function.
- Use a sponge or soft brush and a soap/water solution to clean the vinyl seats. Rinse with clean water.
- Use an automotive type wash cloth to wash the body of the vehicle. To prevent the soap from drying on the vehicle, rinse with clean water frequently.
- Clean the windshield with water and a clean cloth. Remove small scratches with a plastic polish.
- Clean the bottom of the vehicle where mud or dirt can collect. Loosen any packed sediment to help with removal. Be careful not to damage the paint.
- Dry the vehicle with a chamois before the water dries to prevent water spots.

Polishing the Vehicle

- Do not use medium to heavy duty compounds on the finish. Use wax that is for clear coat automotive finishes only. Do not apply wax or polish to matte finish surfaces.
- Use clean or new cloths and pads for polishing. Old or reused cloths and pads can contain dirt particles that will scratch the finish.

TIRES

Follow the tire maintenance procedures as instructed in this manual and on the labels on the vehicle.

Always use approved size and type of replacement tires. See *VEHICLE SPECIFICATIONS* on page 51.



Worn, improperly inflated, improper sized, or incorrectly installed tires will affect vehicle handling and could cause an accident resulting in severe injury or death.

Inflate all tires to the same pressure. Operating with unequal or incorrect pressure can adversely affect steering and handling and could cause an accident resulting in severe injury or death.

To decrease the risk of tire explosion, do not exceed the tire inflation rating on the tire sidewall. Make sure the tires are properly inflated at all times of operation. See *Tire Pressure* on page 12.

To decrease the risk of tire explosion, inflate small amounts of air into the tire at intervals to allow the beads to seat properly. Because of the low volume of the small tires, over inflation can occur in seconds. Never exceed the tire inflation pressure rating on the tire sidewall when seating a bead. Protect your face and eyes when you remove a valve core.

When you remove the wheels, use only sockets made for impact wrenches to decrease the risk of injury by a broken socket.

Do not use tires with low rated pressure. Do not use tires that have a recommended tire inflation pressure less than the tire inflation pressure recommended in the owner's guide.

Do not over inflate the tires. Excess pressure can cause the tire to separate from the wheel or cause a tire explosion.

MAINTENANCE

Tire Pressure

Maintaining correct tire inflation pressure is essential for safe vehicle operation. You can vary the inflation pressure, within the recommended range to suit the condition of the terrain.

TIRE PRESSURE RANGE	TERRAIN CONDITIONS	RECOMMENDATION
18 - 22 psi (124 - 152 kPa)	hard surfaces or pavement	Inflate to higher pressure within the range; never exceed maximum pressure indicated.
	soft terrain or turf	Inflate to lower pressure within the range to reduce potential damage to the terrain or turf.

Tire Repair

Tools

- lug wrench, 3/4"
- impact socket, 3/4"
- impact wrench
- torque wrench, ft.lbs.

NOTICE: Tire plug tools and plugs are available at automotive outlets. The tire does not have to be removed from the wheel to install the tire plug.

Use a tire plug to repair small holes in the tread part of the tire. For large holes or holes/cuts in the tire sidewall, the tire must be replaced.

1. Remove the wheel from the vehicle. See *Wheel Removal* on page 44.
2. Locate the leak in the tire.
 - a. If the tire is very low or flat, fully inflate the tire.
 - b. Brush soapy water over the surface of the tire. Air bubbles will be visible where the air is leaking from the tire.
 - c. Mark the hole with chalk.
3. Install the plug according to the manufacturer's instructions.
4. Install the wheel on the vehicle. See *Wheel Installation* on page 45.
5. Fully inflate the tire. See *Tire Pressure* on page 12.

Tire Replacement

Tire replacement requires a tire mounting machine and must be done by a qualified tire center or your TSV dealer.

WHEELS

WARNING Worn, improperly inflated, improper sized, or incorrectly installed tires will affect vehicle handling and could cause an accident resulting in severe injury or death.

CAUTION To decrease the risk of component damage, do not tighten the lug nuts to more than the torque specified below.

Check lug nuts for tightness at the intervals indicated in the *SCHEDULED MAINTENANCE CHART* on page 40.

Wheel Removal

Tools

- lug wrench, 3/4"
- impact socket, 3/4"
- impact wrench
- torque wrench, ft.lbs.

1. Lift the vehicle. See *LIFTING THE VEHICLE* on page 42.
2. Remove the lug nuts.
3. Remove the tire from the vehicle.

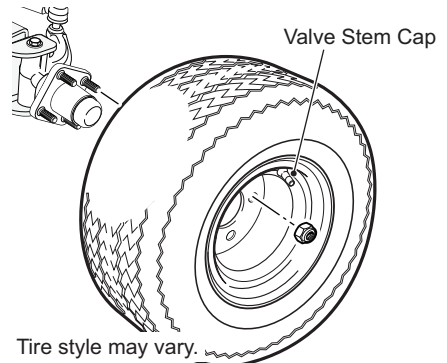

Wheel Installation

Lug Nut Torque	65 - 85 ft.lbs. (88 - 115 Nm)
----------------	-------------------------------

NOTICE: To decrease the risk of component damage, do not tighten the lug nuts to more than the specified torque.

Always install lug nuts using a cross sequence pattern to ensure even seating of the wheel against the hub.

1. Install the wheel on the hub with lug nuts. Make sure the valve stem is to the outside.
2. Finger tighten the lug nuts.
3. Using the tightening pattern shown at right, tighten the lug nuts to 65 - 85 ft.lbs. (88 - 115 Nm). Tighten in increments of 20 ft. lbs. (27 Nm).

Lug Nut Tightening Pattern

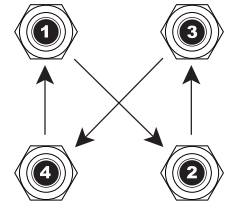

LIGHTS

- Clean the lights frequently to maximize visibility.
- Replace burned out bulbs promptly.

CAUTION

Do not operate this vehicle at night or in low light if any bulbs are burned out. Poor lighting reduces visibility that could cause an accident resulting in severe injury or death.

NOTICE: Replacement bulbs are available from a local distributor, an authorized branch or the service parts department.

Halogen Headlight Bulb Replacement

CAUTION

Light components can get hot if they have been in operation. Allow the lights to cool before servicing to prevent burns to the skin.

NOTICE: Do not touch a halogen bulb with bare fingers. Oil from skin leaves a residue that causes a hot spot and will diminish the life of the bulb.

1. Disconnect the headlight harness from the headlight.
2. Rotate the bulb 1/4-turn to remove the headlight from the housing.
3. Insert and rotate the new bulb to lock into place.
4. Connect the harness to the bulb.

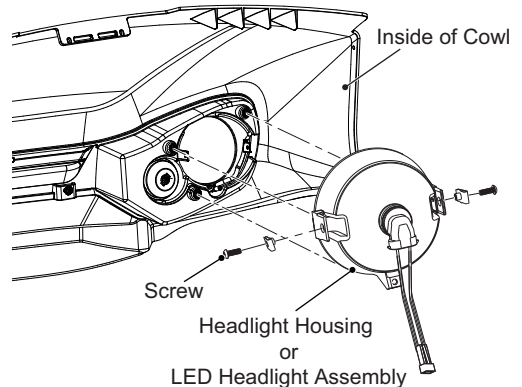

LED Headlight Assembly Replacement

1. Disconnect the headlight harness from the headlight.
2. Remove the screws securing the headlight assembly to the headlight bezel.
3. Remove the headlight assembly and install the new one with screws.
4. Connect the harness to the headlight assembly.

Taillight

1. Roll the rubber bezel from around the edge of the taillight and remove the lens.
2. Install the new bulb.
3. Replace the lens.

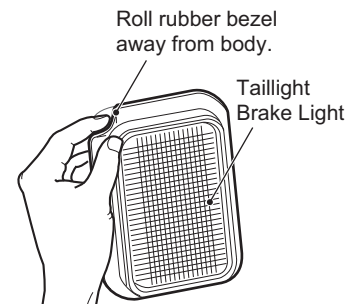

MAINTENANCE

FUSE REPLACEMENT

The fuse block is under the driver seat.

NOTICE: Have the vehicle inspected by your dealer if fuses continue to blow after they have been replaced.

1. Lift the seat bottom to access the fuses.
2. Remove the old fuse and replace with a new fuse of the same type and size.
3. Fuses are available from a local Distributor, an authorized Branch or the Service Parts Department.

CONTROLLER SYSTEM TEST

At monthly intervals, test the controller by allowing the vehicle to roll down an incline with the accelerator pedal released. Braking force should be felt at approximately 2 mph (3 kph) indicating that the system is functioning. If vehicle speed continues to rise, apply the brake and have vehicle inspected by a trained mechanic.

REAR AXLE

The only maintenance necessary for the first five years is the inspection of the rear axle for lubricant leakage. Unless leakage is visible, the lubricant needs to be replaced after five years. Refer to the Service and Repair Manual for the fluid replacement procedure.

Change the axle oil at the intervals indicated in the *SCHEDULED MAINTENANCE CHART* on page 40. The drain plug is located at the bottom of the rear axle housing.

Checking the Lubricant Level

Clean the area around the check/fill plug and remove the plug. The correct lubricant level is just below the bottom of the threaded hole. If lubricant is low, add lubricant as required. Add lubricant (30 WT engine oil) slowly until lubricant starts to seep from the hole. Install the check/fill plug. In the event that the lubricant is to be replaced, the oil pan must be removed or the oil siphoned through the check/fill hole.

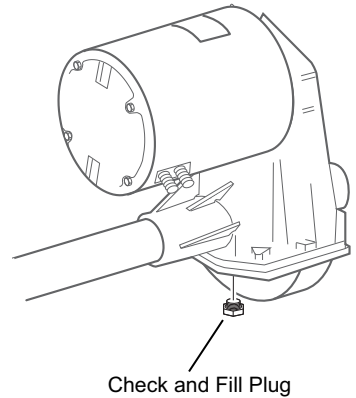

LUBRICATION



CAUTION

Do not use more than three pumps of grease in a grease fitting at any one time. Excess grease can cause grease seals to

fail, or allow grease into areas that could damage components.

Putting more than three pumps of grease in a grease fitting could damage grease seals and cause premature bearing failure.

Lubricate components at the intervals indicated in the *SCHEDULED MAINTENANCE CHART* on page 40.

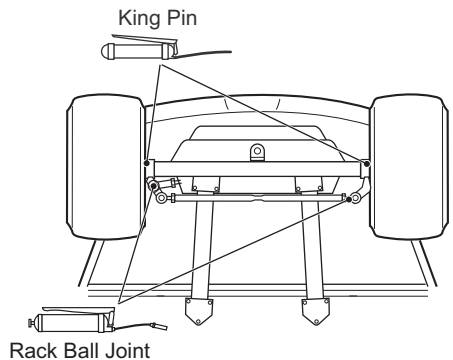

View from Underside of Vehicle

BRAKES



WARNING Always inspect the pedal travel before you operate a vehicle to confirm some brake function is present.

All driving brake tests must be done in a safe location with regard for the safety of all personnel.

NOTICE: Over time, a subtle loss of performance may take place; therefore, it is important to establish the standard with a new vehicle.

Test and service the brake system at the intervals indicated in the *SCHEDULED MAINTENANCE CHART* on page 40.

Periodic Brake Test

The *Periodic Brake Test* must be performed initially and regularly as an evaluation of your vehicle's brake system performance. It is a method of identifying subtle loss of braking performance over time.

Establish the 'acceptable stopping distance' when your vehicle is new and the brakes are at their peak of performance. As your vehicle is used, a subtle loss of braking performance may be detected, so it is important to establish the standard with a new vehicle.

Actual stopping distances are influenced by weather conditions, terrain, road surface condition, vehicle weight and speed. No specific braking distance can be reliably specified, so it is important to establish a base to test with.

The test is conducted by engaging the park brake instead of the brake pedal to eliminate different pedal pressures, to include affects of linkage mis-adjustment and provide a more accurate test.

NOTICE: You must have enough space to accelerate to maximum speed before engaging the parking brake. Use a marker to indicate the predetermined line to engage the parking brake that you will use for the performance test.

1. On a dry, level, clean, paved surface, accelerate the vehicle to maximum speed.
2. Engage the parking brake at the predetermined and marked line.
3. Mark the line where the vehicle comes to a complete stop.
4. If the vehicle stops in a significantly greater distance than the established distance in future tests, or pulls to one side, it should be tested again.
5. If the vehicle fails the second test, discontinue use until it can be inspected and determined safe for operation by a qualified mechanic.

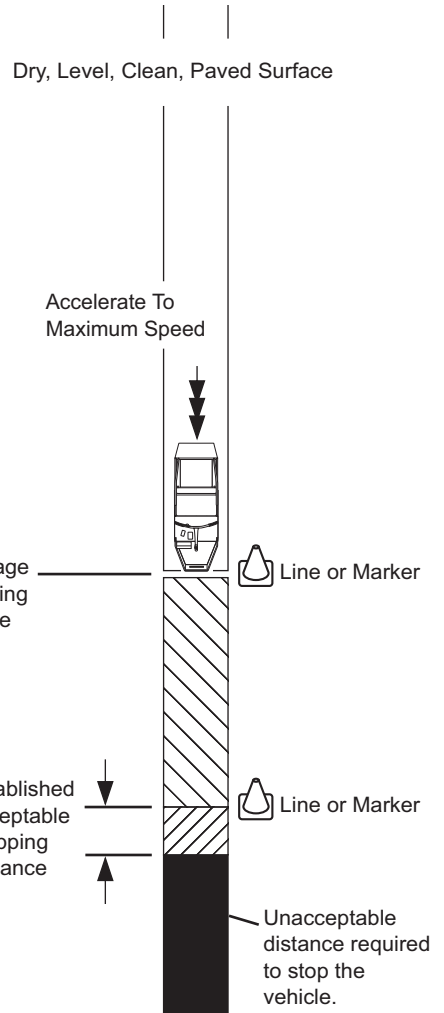

6.

BATTERY

A battery is described as two dissimilar metals immersed in an acid. If the acid is absent or if the metals are not dissimilar, a battery has not been created. The batteries in this vehicle are lead acid.

A battery does not store electricity, but it can produce electricity as the result of a chemical reaction which releases stored chemical energy in the form of electrical energy. The chemical reaction occurs faster in warm conditions and

MAINTENANCE

slower in cold conditions. Temperature is important when conducting tests on a battery and test results must be corrected to adjust for temperature differences.

An older battery can perform adequately except that its capacity is decreased. Capacity describes the time that a battery can continue to supply its design amperes from a full charge.

A battery has a maximum life. Good maintenance maximizes the available life and decreases the conditions that can reduce the life of the battery.

WARNING

Use insulated wrenches to prevent direct contact of a wrench with the battery terminals. Direct contact of a bare wrench with battery terminals can cause an explosion resulting in severe injury or death.

To prevent the risk of battery explosion, keep all flammable materials, open flames or sparks away from the batteries.

Hydrogen gas is made as batteries are charged. Do not charge batteries without good ventilation. A 4% concentration of hydrogen gas is explosive.

Make sure that the key switch is in the OFF position and all electrical accessories are off before you start to work on the vehicle.

Be careful when you use aerosol containers near the battery terminals. Use a container with insulation to prevent an explosion.

Turn off all accessories before disconnecting from the battery terminal.

Always wear a safety shield or approved safety goggles when you add water or charge the batteries.

CAUTION

The electrolyte in a battery is an acid solution which can cause burns to the skin and eyes. Completely clean all electrolyte spills that contact the body and eyes with clear water. Contact a physician immediately.

Do not tilt the batteries during removal or installation. An electrolyte spill can cause burns and damage.

Neutralize electrolyte spills with a solution of 2 teaspoons (10 ml) sodium bicarbonate (baking soda) mixed in 1 quart (1 liter) of water. Clean with water.

Use safe procedures to move the batteries. Always lift the battery with a commercially available battery lifting device.

NOTICE: If you fill the batteries with electrolyte above the maximum level, you can cause an electrolyte spill during the charge cycle. An electrolyte spill can cause damage to the vehicle and storage facility.

BATTERY DISPOSAL

Return used batteries to the manufacturer or lead smelter for recycling purposes. For neutralized spills, put residue in acid-resistant containers with absorbent material such as sand. Dispose in accordance with state and federal regulations for acid and lead compounds. Contact authorized environmental agencies for information about disposal.

BATTERY CLEANING

Clean the batteries according to the Periodic Service Schedule.

CAUTION

Always wear eye protection when cleaning the battery.

To prevent battery damage, make sure you correctly install all battery caps.

NOTICE: To decrease the risk of damage to vehicle or floor, neutralize acid before you spray the battery with water.

To decrease the risk of damage to electrical components surrounding the battery while cleaning, do not use a pressure washer.

When you clean the battery cases and terminals, do not use a water hose without neutralizing any acid deposits first. The water hose moves the acid from the top of the batteries to another area of the vehicle or storage facility, where it can cause damage. After spraying the batteries, a conductive residue remains on the batteries and contribute to the discharge of the batteries

1. Remove corrosion with a wire brush.
2. Wash top and sides of the batteries with a solution of:
 - 2 tsp. (10 ml) baking soda
 - 1 quart (1 liter) water

Wash all metal components near the battery.
3. Allow the solution to set a minimum of three minutes. Use a soft bristle brush or cloth to clean the top of each battery to remove residue that can cause the discharge of the battery.
4. Rinse with tap water and dry with shop towels.
5. After the batteries are clean and dry, coat the terminals with a commercially available battery terminal spray.

BATTERY CHARGING AND MAINTENANCE

⚠ WARNING Hydrogen gas is produced as batteries are charged. Charge batteries only in well-ventilated areas.

Tools

- insulated wrench, 9/16"
- hydrometer
- battery protective spray
- battery carrier
- battery maintenance kit (P/N 25587-G01)

At Each Charging Cycle

- Before you charge the batteries, inspect the plug of the battery charger and vehicle receptacle housing for dirt or other particles.
- Charge the batteries after each use.

Monthly

- Inspect all wires for wear, loose connections, corrosion or damage of insulation.
- Make sure that the electrolyte level is correct and add clean water as required.
- Clean the batteries and wire connections.
- Apply battery protectorate to the battery terminals.

Electrolyte Level and Water

Maintaining correct electrolyte level is important because any part of the plates open to air will be damaged.

Do not overfill batteries with water. Too much water pushes the electrolyte from the battery by release of gas and a decrease in volume of the electrolyte.

The correct level of the electrolyte is 1/2" (13 mm) above the plates in each cell.

This level will leave approximately 1/4" - 3/8" (6 - 10 mm) of space between the electrolyte and the vent tube.

NOTICE: DO NOT overfill batteries. The charge cycle will expel electrolyte and cause component damage in overfilled batteries.

As a battery is being charged, it produces hydrogen gas. Most of this gassing occurs at the end of the charge cycle. Hydrogen gas is lighter than air. Water and sulphuric acid droplets will be carried out of the battery vents by the hydrogen gas, however, this loss is minimum. If the electrolyte level is high, the electrolyte will block the vent tube and the gas will push it out the vent tube and battery cap. The water will dry but the sulphuric acid will stay and damage the vehicle components

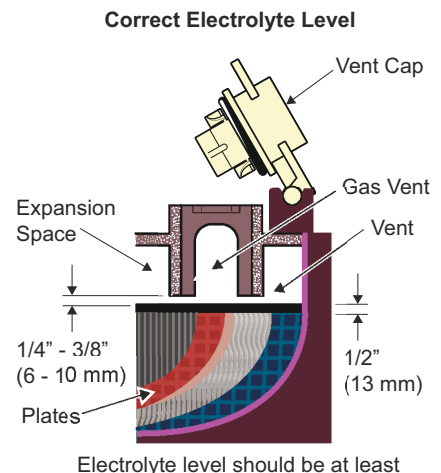

MAINTENANCE

and surface below the vehicle. Sulphuric acid loss will weaken the amount of acid within the electrolyte and decrease the life of the battery.

Over the life of the battery, a large amount of water is used. The water added to the batteries must be clean and without contamination. Unclean water decreases the life of the battery by reducing the chemical reaction. Use distilled water or filtered water only. Test water that is not distilled water and filter if needed. Refer to the following water purity table for requirements.

IMPURITY	PARTS PER MILLION
color	clear
suspended	trace
total solids	100
calcium and magnesium oxides	40
iron	5
ammonia	8
organic and volatile matter	50
nitrites	5
nitrates	10
chloride	5

WARNING The electrolyte in a battery is an acid solution which can cause severe burns to the skin and eyes. Clean all electrolyte spills to the body and eyes with clear water. Contact a physician immediately.



Always wear a safety shield or approved safety goggles when you add water or charge the batteries.

Hand held watering devices available at automotive parts stores, or automatic watering devices like the one included in the Battery Maintenance Kit (P/N 25587-G01) can be used with an approved water supply. These watering devices are accurate, easy to use and allow for fast fill. They also keep the correct electrolyte level within the battery cells.

NOTICE: The watering device should only be used if the electrolyte level is less than 1/2" (13 mm) above top of plates.

To clean an electrolyte spill, use a solution of:

- 2 tsp. (10 ml) baking soda
- 1 quart (1 liter) water

Wash all metal components near the battery.

Watering device similar to the type included in the Battery Maintenance Kit

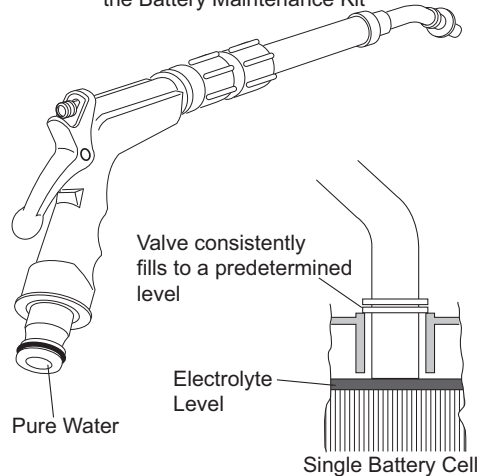

BATTERY REPLACEMENT

CAUTION Before you disconnect or connect a battery or any other wires, move the run/tow switch to TOW position.

After you connect a battery or any other wires, wait a minimum of 30 seconds before you move the run/tow switch to the RUN position.

1. Remove the battery hold downs and cables.
2. Remove the batteries with a commercially available lifting device.

3. If the batteries have been cleaned and the acid in the battery rack area is neutralized as recommended, no corrosion to the battery racks or surrounding area should be present. If any corrosion remains, remove it with a putty knife and a wire brush. Wash the area with a sodium bicarbonate (baking soda) and water solution, and then dry before primer and corrosion resistant paint is applied.
4. Put the batteries in the battery racks and tighten the hold downs to 45 - 55 in. lbs. (5 - 6 Nm) torque. The hold downs must be tight enough to prevent movement of the battery, but not tight enough to cause distortion of the battery cases.
5. Inspect all wires and terminals. Clean corrosion from the battery terminals or the wire terminals with a sodium bicarbonate (baking soda) and water solution and soft brush if needed.

WARNING

Be careful when using aerosol containers near battery terminals. Always use a container with insulation to prevent an explosion.

6. Connect the battery wires as shown.
7. Tighten the battery post hardware to 90 - 100 in. lbs. (6 - 8 Nm) torque. Do not over-tighten the terminal stud nut, this will cause a "mushroom" effect on the battery post which will prevent the terminal nut from being correctly tightened.
8. Protect the battery terminals and battery wire terminals with a commercially available coating.

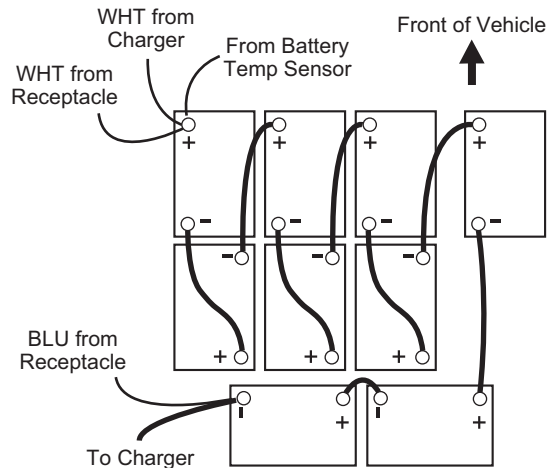

BATTERY STORAGE

NOTICE: Disconnect the battery charger, controller and other electronic devices for extended storage. All connected electronic components cause the discharge of batteries.

Put the run/tow switch in the TOW position for extended storage of the vehicle to prevent draining of the batteries.

During storage, the batteries must not be allowed to discharge.

MAINTENANCE

In high temperatures the chemical reaction is fast, while low temperatures cause the chemical reaction to slow. A vehicle that is stored at 90° F (32° C) will lose .002 of specific gravity each day. If a completely charged battery has a specific gravity of 1.275, and the battery is not used, it will become partially discharged. When it reaches 1.240, which it will do in less than 20 days, it must be charged again. If a battery stays in a discharged state, sulfating occurs on and within the plates. This condition is not reversible and will cause permanent damage to the battery. To prevent damage, the battery must be charged again. Use a hydrometer to find the specific gravity and the state of charge of a battery.

In winter conditions, the battery must be completely charged to prevent the risk of freezing. A completely charged battery will not freeze in temperatures above -75° F (-60° C). Although the chemical reaction is decreased in cold temperatures, the battery must be stored completely charged, and disconnected from circuits that can discharge the battery. The controller must be disconnected from the batteries by setting the run/tow switch to the TOW position.

For portable chargers, disconnect the charger plug from the vehicle receptacle.

For on-board chargers, disconnect the charging harness from the batteries.

The batteries must be cleaned and all deposits neutralized and removed from the battery case to prevent self discharge.

The batteries must be tested or charged again at 30 day minimum intervals.

BATTERY CHARGING

The battery charger is designed to completely charge the battery set. If the batteries are severely deep cycled, some automatic battery chargers contain an electronic module that will not activate and the battery charger will not operate. Automatic chargers determine the correct length of charge to the battery set and turns off when the batteries are charged. Always refer to the instructions of the charger used.



Do not overfill batteries. The charge cycle will expel electrolyte and cause component damage.

Before charging, observe the following:

- The electrolyte level in all cells must be at the recommended level and above the plates.
- Charging must occur in an area with good ventilation to remove hydrogen gas that is produced during the charge cycle. A minimum of five air replacements for each hour is recommended.
- The charger connector components must be in good condition and free from dirt and particles.
- The charger connector must be completely plugged into the vehicle receptacle.
- The charger connector and cord set must be protected from damage. The charger connector and cord set must be used in an area where it is not possible for personnel to run over or trip over the cord set.
- The charger automatically turns off during the connect and disconnect cycle, so there is no electrical arc generated at the DC plug and receptacle contacts.

AC Voltage

The battery charger output is directly related to the input voltage. If the vehicle receives an incomplete charge in a normally adequate time period, low AC voltage can be the cause. Consult an electrician if necessary.

BATTERY FAULT DIAGNOSIS

Fault diagnosis is done for two reasons:

- A battery that performs poorly and is outside of the manufacturers specification must be identified to replace it within the terms of the manufacturer's warranty. Different manufacturers have different requirements. Refer the battery manufacturer or the manufacturer's representative for specified requirements.

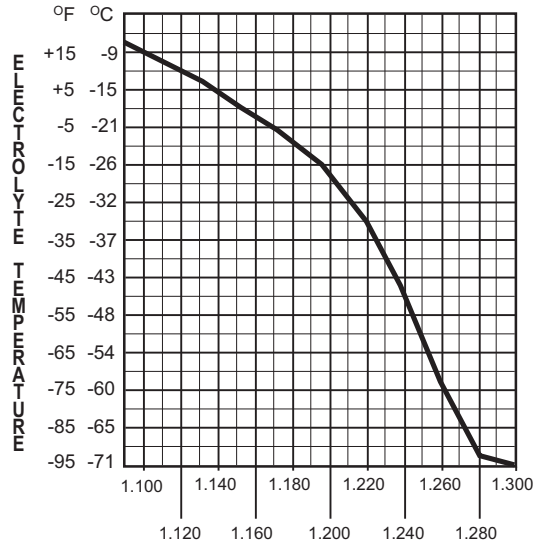

SPECIFIC GRAVITY ELECTROLYTE FREEZING POINT

- Find the reason a vehicle does not perform adequately. Performance problems can cause a vehicle to run slowly or can not operate for the time needed.

A new battery must mature before it develops its maximum capacity. Maturing can take 100 or more charge and discharge cycles. After the maturing phase, the older a battery gets, the lower the capacity. The only method to find the capacity of a battery is a load test with a discharge machine. Refer to the discharge machine manufacturer instructions.

A hydrometer is used to identify a poorly performing battery in a set with a low specific gravity. When the particular cell or cells that are the problem are identified, the battery can be removed and replaced. The battery can not be restored. The individual battery should be replaced with a good battery of the same brand, type and approximate age. Hydrometer

WARNING To prevent battery explosion, never insert a metal thermometer into a battery. Use a hydrometer with a built in thermometer that is designed for testing batteries.

A hydrometer (P/N 50900-G1) is used to test the state of charge of a battery cell. This is performed by measuring the density of the electrolyte, which is accomplished by measuring the specific gravity of the electrolyte. The greater the concentration of sulfuric acid, the more dense the electrolyte becomes. The higher the density, the higher the state of charge.

Specific gravity is the measurement of a liquid that is compared to a baseline. The baseline is water which is assigned a base number of 1.000. The concentration of sulfuric acid to water in a new golf car battery is 1.280 which means that the electrolyte weighs 1.280 times the weight of the same volume of water. A fully charged battery will test at 1.275 - 1.280 while a discharged battery will read in the 1.140 range.

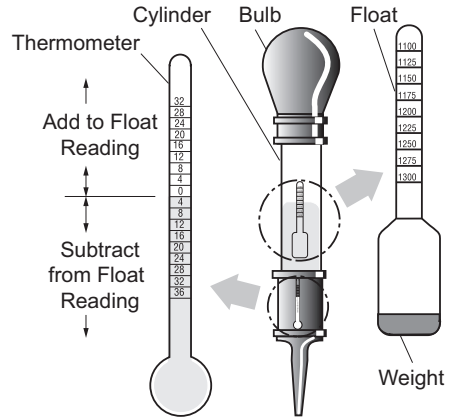

NOTICE: Do not perform a hydrometer test on a battery that has just been watered. The battery must go through at least one charge and discharge cycle in order to permit the water to adequately mix with the electrolyte.

The temperature of the electrolyte is important since the hydrometer reading must be corrected to 80° F (27° C). High quality hydrometers are equipped with an internal thermometer that will measure the temperature of the electrolyte and will include a conversion scale to correct the float reading. It is important to recognize that the electrolyte temperature is significantly different from the ambient temperature if the vehicle has been operated.

MAINTENANCE

Using A Hydrometer

1. Draw electrolyte into the hydrometer and release it several times to permit the thermometer to adjust to the electrolyte temperature and note the reading. Examine the color of the electrolyte. A brown or gray coloration indicates a problem with the battery and is a sign that the battery is nearing the end of its life.
2. Draw the minimum quantity of electrolyte into the hydrometer to permit the float to float freely without contacting the top or bottom of the cylinder.
3. Hold the hydrometer in a vertical position at eye level and note the reading where the electrolyte meets the scale on the float.
4. Add or subtract four points (.004) to the reading for every 10° F (6° C) the electrolyte temperature is above or below 80° F (27° C). Adjust the reading to conform with the electrolyte temperature, e.g., if the reading indicates a specific gravity of 1.250 and the electrolyte temperature is 90° F (32° C), add four points (.004) to the 1.250 which gives a corrected reading of 1.254. Similarly if the temperature was 70° F (21° C), subtract four points (.004) from the 1.250 to give a corrected reading of 1.246.
5. Test each cell and note the readings (corrected to 80° F or 27° C). A variation of fifty points between any two cell readings (example 1.250 - 1.200) indicates a problem with the low reading cell(s).

As a battery ages the specific gravity of the electrolyte will decrease at full charge. This is not a reason to replace the battery providing all cells are within fifty points of each other. Since the hydrometer test is in response to a vehicle exhibiting a performance problem, the vehicle should be recharged and the test repeated. If the results indicate a weak cell, the battery or batteries should be removed and replaced with a good battery of the same brand, type and approximate age.

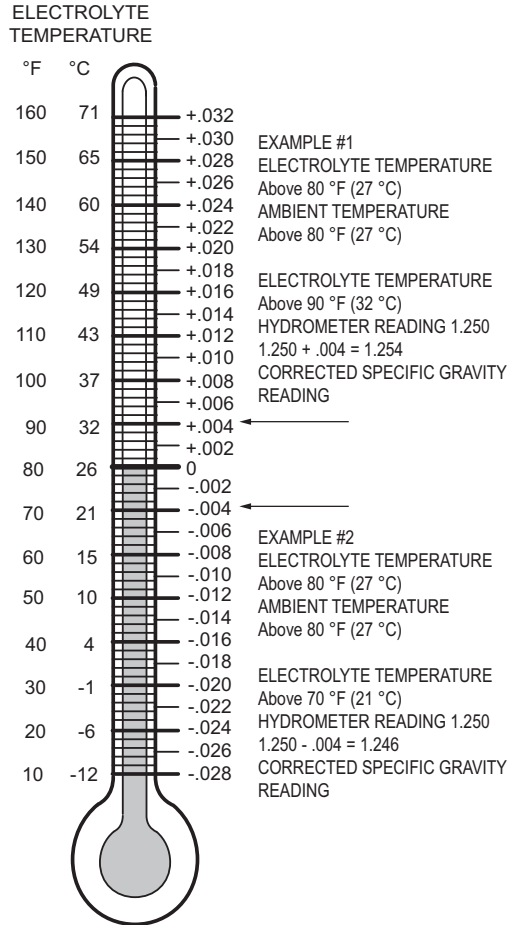

Hydrometer Temperature Correction

TRANSPORTING THE VEHICLE



Do not ride or allow other people on a vehicle being transported on a trailer or being towed with another vehicle.

Towing the Vehicle



Do not try to tow the vehicle with ropes, chains or any device different from a tow bar approved by the manufacturer.

Do not tow the vehicle on highways.

Do not tow the vehicle at speeds more than 12 mph (19 kph).

Hauling the Vehicle



Loose cargo or vehicle components can fly off when the vehicle is being transported. Secure or remove all cargo. Inspect the vehicle for loose components prior to transport.

Do not allow any people on a vehicle being transported on a trailer.

Remove the windshield before you transport a vehicle on a trailer.

Maximum speed with canopy top installed is 50 mph (80 kph).

- If the vehicle is being hauled on a trailer or truck at highway speeds, the canopy top must be removed.
 - If the vehicle is being hauled on a trailer or truck below highway speeds, check that canopy top hardware is tight and there are no cracks in the canopy top at the mounting points.
 - The rated capacity of the hauling trailer or truck must be more than the weight of the vehicle and load plus 1000 lbs. (454 kg). See GENERAL SPECIFICATIONS for the weight of the vehicle.
1. Drive the vehicle onto the trailer or truck.
 2. Engage the parking brake. Leave the direction selector in F (forward).
 3. Turn the key switch to the OFF position. To prevent loss of the key, remove it from the ignition switch.
 4. Make sure the seats are secured.
 5. Secure the vehicle to the trailer or truck with tie downs, straps or ropes.

SPECIFICATIONS

HAULER PRO-X - VEHICLE SPECIFICATIONS

• Solid State continuously variable AC speed controller	• Full torque, reduced speed reverse
• Seatwrap mounted direction selector switch (Forward-Neutral-Reverse)	• Inductive throttle sensor
• Anti-roll back, walkway braking and alarm	• Diagnostic indicator
• Anti-stall motor protection	• Factory programmable to application
• Regenerative 'Pedal Down' and/or 'Pedal Up' braking	
Battery Charger: 900 Watt, 72 VDC, 120/230 VAC 50/60 Hz. Underwriters Laboratories (U.L.) Listed, (C.S.A. Certified)	
Motor: 72 Volt AC Induction, solid copper windings. Non vented 22.4 hp (16.7 kW) Peak.	
Drive Train: Direct motor shaft connected to transaxle pinion shaft	
Electrical System: 72 Volt DC, nine, 8 volt deep cycle storage batteries (78 minutes @ 75 Amps, 170 amp-hour @ 20 hour discharge rate)	
Transaxle: Differential with helical gears	
Brakes: Dual rear wheel mechanical self-adjusting drum brakes. Automatic single point park brake release with self-compensating system.	
Cargo Bed: Roto-molded cross-linked polyethylene. Lifts for access to powertrain. Removable hinged multi-position tail-gate with cam over latch mechanism.	
Item	Specification
Overall Length	119 in. (302 cm)
Overall Width	49 in. (125 cm)
Overall Height (No Canopy)	53 in. (135 cm)
Overall Height (With Canopy)	77 in. (195.58 cm)
Wheel Base	77.5 in. (197 cm)
Front Wheel Track	38 in. (97 cm)
Rear Wheel Track	38.5 in. (97.79 cm)
Ground Clearance (at Differential)	7.2 in. (18 cm)
Cargo Box Width (inside)	44 in. (112 cm)
Cargo Box Length (inside)	39 in. (99 cm)
Cargo Box Depth (inside)	12 in. (30 cm)
Cargo Box Capacity	12 cu ft. (0.34 cu m)
Cargo Box material	Roto-molded polyethylene
Power Source	72 Volts DC
Motor Type	AC Induction
Horsepower (kW)	22.4 hp (16.7 kW) Peak
Electrical System	72 Volt
Batteries (Qty, Type)	Nine, 8 Volt Deep Cycle
Key or Pedal Start	Pedal Start
Battery Charger	900 Watt, 72VDC
Speed Controller	350 Amp AC

SPECIFICATIONS

Drive Train	Motor Shaft Direct Drive
Transaxle	Differential with helical gears
Gear Selection	Seatwrap Mounted Forward-Neutral-Reverse
Rear Axle Ratio	17:1
Seating Capacity	2 Person or 4 person with optional flip seat
Dry Weight	948 lb. (430 kg) (Without Batteries)
Curb Weight	1513 lb. (686 kg)
Bed Load Capacity	500 lb. (227 kg)
Vehicle Load Capacity	900 lb. (408 kg)
Outside Clearance Circle	23.5 ft. (7.2 m)
Speed (Level Ground)	16.5 mph \pm 0.5 mph (26.5 kph \pm 0.80 kph)
Maximum Drawbar	930 lb. (4137 N)
Towing Capacity	1200 lb. (544 kg) max load
Steering	Self-compensating rack and pinion
Front Suspension	Leaf springs with hydraulic shock absorbers
Rear Suspension	Leaf springs with hydraulic shock absorbers
Service Brake	Rear wheel mechanical self-adjusting drum
Parking Brake	Self-compensating, single point engagement
Front and Rear Tires	K500 20 X 8 - 10 (6 Ply), Black Wheel
Frame	Welded steel. DuraShield™ powder coat
Front Body and Finish	Injection Molded TPO
Standard Color	Forest Green
Noise	Sound pressure; continued A-weighted \leq 70 db(A)
Vibration, WBV	Highest RMS value of weighted acceleration is less than 2.5 m/s
Vibration, HAV	Highest RMS value of weighted acceleration is less than 2.5 m/s The uncertainty of measurement is 0.12 m/s
	Measurement methods were applied per the ISO 2631 and ISO 5349 standards under conditions of typical vehicle surfaces.
<i>Some items shown may be optional equipment</i>	

APPENDIX A

DELTA-Q USER'S GUIDE

SAVE THESE IMPORTANT SAFETY INSTRUCTIONS



This manual contains important safety and operating instructions – read before using charger.

Warning: Use charger only with an algorithm selected that is appropriate to the specific battery type. Other usage may cause personal injury and damage. Lead acid batteries may generate explosive hydrogen gas during normal operation. Keep sparks, flames, and smoking materials away from batteries. Provide adequate ventilation during charging. Never charge a frozen battery. Study all battery manufacturers' specific precautions, i.e. maximum charge rates and if cell caps should be removed while charging.

Danger: Risk of electric shock. Connect charger power cord to an outlet that has been properly installed and grounded in accordance with all local codes and ordinances. A grounded outlet is required to reduce risk of electric shock – do not use ground adapters or modify plug. Do not touch uninsulated portion of output connector or uninsulated battery terminals. Disconnect the AC supply before making or breaking the connections to the battery. Do not open or disassemble charger. Do not operate this charger if the AC supply cord is damaged or if the charger has received a sharp blow, been dropped, or otherwise damaged in any way – refer all repair work to the manufacturer, or qualified personnel. This appliance is not intended for use by persons (including children) with reduced physical, sensory or mental capabilities, or lack of experience and knowledge, unless they have been given supervision or instruction concerning use of the appliance by a person responsible for their safety. Children should be supervised to ensure that they do not play with the appliance.

INFORMATIONS IMPORTANTES DE SÉCURITÉ



Ce manuel contient des instructions importantes concernant la sécurité et le fonctionnement.

Attention: Utiliser le chargeur seulement avec un algorithme approprié au type spécifique de batterie. D'autres types de batteries pourraient éclater et causer des blessures ou dommages. Les batteries peuvent produire des gaz explosifs en service normal. Ne jamais fumer près de la batterie et éviter toute étincelle ou flamme nue à proximité des batteries. Fournissez une ventilation adéquate du chargement. Ne jamais charger une batterie gelée. Prendre connaissance des mesures de précaution spécifiées par le fabricant de la batterie, p. ex., vérifier s'il faut enlever les bouchons des cellules lors du chargement, et les taux de chargement.

Danger: Risque de chocs électriques. Ne pas toucher les parties non isolées du connecteur de sortie ou les bornes non isolées de la batterie. Toujours connecter le chargeur à une prise de courant mise à la terre. Déconnectez la source AC avant de faire ou défaire les connexions à la batterie en chargement. Ne pas utiliser le chargeur si le cordon d'alimentation AC est endommagé ou si le chargeur est abîmé suite à une chute ou autre incident. Ne pas ouvrir ni désassembler le chargeur – référer toute réparation aux personnes qualifiées. Cet appareil n'est pas destiné à un usage par des personnes (dont les enfants) avec des facultés motrices, sensorielles ou mentales réduites, ou ayant une expérience et des connaissances insuffisantes, à moins qu'elles sont sous la supervision ou reçoivent les instructions sur l'utilisation de l'appareil d'un répondant garant de leur sécurité. Les enfants devraient être surveillés afin qu'il ne jouent en aucun temps avec l'appareil.

Operating Instructions

CAUTION: Charger enclosure may be hot during charging. Use hand protection if handling the charger while charging.



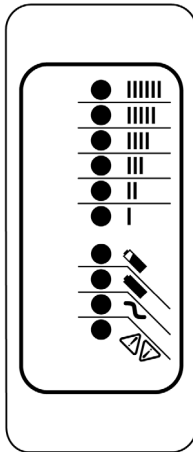

1. Extension cords must be 3-wire cord no longer than 30m(100') at 10AWG or 7.5m(25') at 16AWG per UL guidelines.
2. Only connect **ONE** QuiQ charger to a single 15A circuit or the circuit may become overloaded.
3. Charger 10-LED Display:

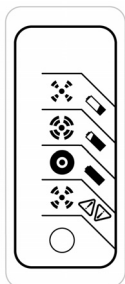

LED Colour	Indication (following "Power-On Self Test")	
Ammeter (Amber)	Solid:	Displays approximate scale of current output during bulk phase.
	Flashing:	High internal charger temperature. Output reduced. Also displays algorithm #1-6 for 11 seconds if no battery is connected.
80% Charge (Amber)	Solid:	Bulk charge phase complete, 80% charged. In Absorption phase.
	Flashing:	With no battery connected, indicates algorithm # selected by number of flashes.
100% Charge (Green)	Solid:	Charging complete. Charger in Maintenance Mode.
	Flashing:	Absorption phase complete. In Finish phase
AC On (Amber)	Solid:	AC Power good
	Flashing:	Low AC Voltage, check voltage and extension cord length (see above for guidelines).
Fault (Red)	Flashing:	Charger error. Reset charger power and refer to Troubleshooting Instructions below.

4. Optional Charger Single-LED Display (internal or external)









LED Colour	Indication (following "Power-On Self Test")	
Green	 	Solid: Charging complete. Charger in Maintenance Mode. Flashing: <i>Short:</i> <80% Charge. <i>Long:</i> >80% Charge. When battery is not connected: Algorithm Number display.
Amber		Flashing: Reduced Power Mode: Low AC Voltage or High internal charger temperature.
Red		Flashing: Charger error. Reset charger power and refer to Troubleshooting Instructions below.

Maintenance Instructions

- Do not expose charger to oil, dirt, mud or direct heavy water spray when cleaning vehicle.
- If the detachable input power supply cord set is damaged, replace with a cord that is:
 - for North America - UL or CSA listed/approved detachable cord, 3 conductor, 16AWG minimum, and rated SJT; terminating in a grounding type IEC 60320 C14 plug rated 250V, 13A minimum; or
 - for all other countries – a safety approved detachable cord, 3 conductor, 1.5mm² minimum, rated appropriately for industrial use. The cord set must be terminated on one end with a grounding type input connector appropriate for use in the country of destination and, on the other end, an output grounding type IEC 60320 C14 plug.
- The enclosure of the charger has been tested successfully to EN60529, meeting IP66. The AC supply inlet is rated to IP20, which is suitable for indoor use only. Keep all AC connections clean and dry.

Troubleshooting Instructions

If a fault occurs, count the number of red flashes between pauses and refer to the table below:

Red Flashes	Cause	Solution
	Battery High Voltage	Check battery size and condition and reset charger (interrupt AC power for 15 seconds).
	Battery Low Voltage	Check battery size and condition and reset charger (interrupt AC power for 15 seconds).
	Charge Timeout caused by battery pack not reaching required voltage. Charger output was reduced due to high temperatures	Check connections. Operate charger at a lower ambient temperature.
	Check Battery: battery could not be trickle charged up to minimum voltage	Check for shorted or damaged cells.
	Over-Temperature: Charger shut down due to high internal temperature.	Ensure sufficient cooling air flow and reset charger (interrupt AC power for 15 seconds).
	Charger Internal Fault	Reset charger (interrupt AC power for 15 seconds). Return to qualified service depot if fault persists.

Note: This is a Class A product complying with United States Federal Communications Commission, Code of Federal Regulations; 47CFR part 15. In a domestic environment this product may cause radio interference, in which case the user may be required to take adequate measures.

2009 © Delta-Q Technologies Corp. All rights reserved. PN: 710-0098 Rev 1

INDEX

A

auxiliary outlet, 12V 17

B

battery disposal 7
battery maintenance 47
bed lift switch, electric 17
brakes 47

C

cable, winch 37
capacity
 cargo load 12, 30
 fluids 41, 55
 hitch 33, 55
 load 55
 towing 33, 55
cargo
 dumping 32
 hauling 30
 maximum load 12, 30
cleaning the vehicle 43

D

direction selector 19
driving procedures
 accelerating 26
 braking 27
 downhill 28
 parking 29
 passenger 27
 reverse 29
 slippery surfaces 28
 stalling on hill 29
 traversing hillsides 28
 uphill 28

E

engine
 starting 26

F

fluids
 capacities 41
 recommended 41

G

glove box 19

H

hauling, vehicle 55
headlights 45

hitch weight capacity 33
horn switch 17

K

key switch 17

L

labels, safety 9
lifting, vehicle 15, 42
lubricants, recommended 41

M

maintenance
 chart 40
 fluid capacities 41
 recommended fluids and lubricants 41
 scheduled 39
 winch 38

N

neutral lock 55

O

operator safety 12

P

PIN plate 8
pre-ride inspection 23

R

registration information, vehicle 7

S

safety
 cargo 12, 30
 driving downhill 14
 driving in reverse 14
 driving uphill 14
 driving with passenger 13
 labels 9
 lifting, vehicle 15, 42
 operation 23
 operator 12
 pre-ride inspection 23
 slippery terrain 15
 stalling 15
 tire pressure 12, 44
 tires 15
 towing 33
 unauthorized use 13
 vehicle modification 15
 weight capacity 12, 30
 winch 35

INDEX

- safety symbols 7
- scheduled maintenance chart 40
- seat bottom 19
- serial number labels 8
- shock loading, winch 38
- slippery surfaces 28
- specifications, vehicle 55
- steering wheel 18
- storage compartments 19
- switches
 - bed lift, electric 17
 - horn 17
 - key 17

T

- tires 43
 - pressure 12, 44
 - repair 44
 - replacement 44
- towing
 - capacity 33
 - speeds 33
- towing, vehicle 55
- transporting the vehicle 55
- truck bed 19
 - dumping 32

U

- USB port 17

V

- vehicle
 - hauling 55
 - specifications 55
 - towing 55
 - transporting 55
- vehicle identification numbers 8

W

- warranty information, vehicle 7
- washing the vehicle 43
- weight capacity, maximum 12, 30
- wheels 44, 45
 - axle and wheel nut torques 44
 - wheel installation 45
 - wheel removal 44
- winch
 - cable care 37
 - maintenance 38
 - operation 36
 - safety 35
 - shock loading 38

Normal use, age and wear on vehicle components can affect the safe operation and reliability of the vehicle. The recommended inspection and maintenance procedures are crucial for safety, performance, reliability and maximum longevity of your vehicle.

A damaged vehicle, or a vehicle that is not functioning properly is dangerous and must not be operated until repairs are made.

NOTICE: Read the following operational warnings before driving the vehicle:

⚠ WARNING

Before you leave the vehicle, turn the key to the OFF position and remove the key from the vehicle to prevent unauthorized use.

Drive the vehicle at appropriate speeds for the terrain and conditions. Be aware of environmental conditions that change the terrain and your ability to control the vehicle.

Do not drive on excessively steep hills. Evaluate the terrain before descending a hill. Drive slowly and deliberately. Use the brake to limit speed and maintain control. Sudden braking or turning can cause loss of vehicle control. Drive straight down the hill; do not drive across the hill.

Operate in approved areas.

Keep feet, legs, hands and arms inside vehicle at all times.

Avoid driving on terrain that is too rough for your vehicle's capabilities and your driving skills.

Before you drive in the reverse direction, make sure the area behind the vehicle is clear. Accelerate slowly and avoid making sharp turns.

Make sure the direction selector is in the correct position before you press the accelerator pedal.

Decrease speed before and during turns.

Bring the vehicle to a complete stop before you move the direction selector.

See GENERAL SPECIFICATIONS for the vehicle load and seat capacity.

NOTICE: Read the following maintenance information and warnings before servicing or repairing the vehicle:

Follow the procedures and comply with the safety information in this manual while performing vehicle service or maintenance.

Use the tools shown in the tool list and wear the specified safety equipment when performing vehicle service or maintenance.

⚠ WARNING

Remove all jewelry before you service the vehicle.

Do not allow loose clothing or hair to contact the moving parts.

Do not touch hot objects.

The drive wheels must be lifted and supported on jack stands before you perform any service to the powertrain while the motor is in operation.



When you service the vehicle, always wear eye protection. Be careful when working around batteries, using solvents or compressed air.

Use insulated wrenches to decrease the risk of a short-circuit if a wrench contacts the battery terminals. A short-circuit in a battery can cause an explosion.

To prevent the risk of battery explosion, keep all flammable materials, open flames or sparks away from the batteries.

Hydrogen gas is produced as batteries are charged. Charge batteries only in well-ventilated areas.

Maintain constant awareness that some components are heavy, spring loaded, corrosive, explosive, can cause high amperage or get extremely hot. Battery acid and hydrogen gas can cause bodily injury. Keep your hands, face, feet and body away from any area that can expose them to injury if an unexpected situation occurs.



CUSHMAN™

CUSHMAN

1451 Marvin Griffin Road, Augusta, Georgia 30906 - 3852 USA

TO CONTACT US:

North America:

Technical Assistance & Warranty Phone: 1-800-774-3946, FAX: 1-800-448-8124

Service Parts Phone: 1-888-438-3946, FAX: 1800-752-6175

International:

Phone: 001-706-798-4311, FAX: 001-706-771-4609

Website:

www.cushman.com

Service Parts Manuals and Repair and Service Manuals
are available from a local Distributor, or an authorized Branch.

Copyrighted Material
This manual may not be reproduced in whole or in
part without the express permission of
TSV (Augusta),
Technical Communications Department